

# SUSTAINABLE. USEFUL. SAFE. SENATOR.

Pens,  
Notebooks  
and Mugs

catalogue  
2021



**senator**<sup>®</sup>  
Extramoreordinary. Since 1920.

Dear Senator customers,

We look forward to being a reliable partner for you in these times. As in previous years, we have made improvements and additions to the catalogue and range without losing sight of continuity.

We would like to point out three special highlights for the products:

- Our NFC pens for the perfect combination of haptic and electronic advertising
- The Challenger ballpoint pen made from recycled plastic in many colour combinations
- As well as the Antibac series, which is now also certified against Corona

The following applies for 2021:

- All material prices of the pens are unchanged (rounded to two places)
- The printing prices have been simplified significantly
- Preliminary costs are now included in the printing prices

Almost the entire range of cups and mugs will be switched to "Made in Germany" on July 1st, 2021, with the industry price (RRP) only increasing by € 0.30.

We look forward to the year 2021 with you as a partner.

Yours,

Daniel Jeschonowski  
Group CEO Senator



**ABOUT US**

**SUSTAINABLE.  
USEFUL.  
SAFE.  
SENATOR.**

senator® products stand out because they represent a thorough concept targeting individualised brand presentation: a broad range of designs, dependable production and customised printing mean they offer a perfect match with your brand.



**SINCE 1920  
QUALITY MADE IN GERMANY**

Production and development of writing instruments has been our passion for 100 years. Our value chain within Germany and our many years of production know-how are your assurances for long life products to achieve advertising success. From July 2021, many of our mug models will be 'Made in Germany'.



**DURABLE PRODUCTS  
AND SUSTAINABLE PROCESSES**

We attach great importance to the environment. That's why our materials and production processes are designed to be free of harmful substances, ecologically compatible, waste avoiding and recyclable. We purchase green electricity from hydropower, invest in energy-saving measures and develop our products in such a way that they have a long product life.

**STRONG PROMO ARTICLES  
ON DESKTOPS**

senator® ball pens and mugs are the perfect accompaniment during everyday work. They boast persuasive functionality to help them quickly become products which are used every day, providing the ideal vehicle for advertising logos again and again, day by day.

**WE ACCEPT RESPONSIBILITY  
FOR YOUR SAFETY**

senator® products are always the safe choice and fulfil all legal requirements. To us, the BSCI and Sedex membership is as self-evident as the certification according to ISO 9001, 14001 and SMETA.



# OUR SERVICES AT A GLANCE

## WIDE COLOUR RANGE

With senator® your corporate colour is in safe hands. In addition to a large selection of standard colours, we are happy to bring your desired colour to life when designing your writing instrument or mug. With our PMS service we will realize your personal desired colour tone.

Page 100



## BIOBASED AND RECYCLED PLASTIC PRODUCTS

At senator® we are actively following the research and investment in alternative materials to reduce the carbon footprint and see this development very positively! Currently, we are already using bio-based plastics made from sugar cane in four successful ball pen models and now, three models made from post-industrial recycled plastic.

Pages 8-15



## 5000 IN 5 EXPRESS SERVICE

Benefit from the advantages of the unique senator® "5000 in 5" service. Your ball pen orders in quantities of up to 5,000 will be produced, printed in up to 5 colours, packaged and ready for dispatch within 5 days.

Page 102

## PERFECT PRINT TECHNOLOGY FOR EVERY BRAND IDENTITY

The full range of spectacular printing options for our writing instruments and mugs are the guarantees to provide the best presentation for your brand identities. We can help you in selecting the most suitable branding options, and design your promotional items to leave lasting impressions.

Pages 104-109



NEW

## DIGITAL SOLUTIONS

Use the senator® Challenger now with an integrated NFC tag and transmit additional digital information. As soon as you hold an NFC-enabled smartphone to the pre-programmed NFC tag, you will see the additional information linked to the chip – individually tailored to your wishes, always up to date and alterable any time.

Page 103



NEW

## ORDER ONLINE NOW AT MY.SENATOR.COM

Now you can easily place your orders online at any time. Including print approval with production. Fast and uncomplicated. You have access to all the information on our best sellers at any time. Your direct line to senator®: [my.senator.com](https://my.senator.com)

Page 102

# OUR PENS

## PLASTIC PENS

<p><b>NEW</b> <b>NEW</b> <b>NEW</b></p> <p><b>Evoxx</b> <b>Trento</b> <b>Challenger</b></p> <p>3273 Polished Recycled 3305 Matt Recycled 3402 Matt Recycled 3403 Matt Recycled Mix &amp; Match</p> <p>10 11 12 12</p>				<p><b>Liberty</b> <b>Keye</b> <b>Super Hit</b> <b>Nature Plus</b></p> <p>3310 Bio 3290 Bio 3300 Bio 2796 Bio</p> <p>13 14 15 15</p>				<p><b>NEW</b> <b>NEW</b> <b>NEW</b></p> <p><b>Challenger</b> <b>Super Hit</b> <b>Liberty</b></p> <p>3401 Polished Antibac 3306 Polished Antibac 3407 Polished Basic Antibac</p> <p>16 17 17</p>			<p><b>Headliner</b></p> <p>3285 Soft Touch 3281 Clear Basic 3280 Polished Basic</p> <p>18 19 19</p>							
<p><b>Bridge</b></p> <p>3251 Clear 3253 Clear MT 3250 Polished 3252 Polished MT 3257 Soft Touch 3256 Mix &amp; Match</p> <p>20 20 21 21 22 22</p>							<p><b>Liberty</b></p> <p>2983 Clear 2915 Polished 2993 Polished Basic 2015 Soft Touch 2942 Soft Touch MC 2918 Mix &amp; Match 2829 Mix &amp; Match Soft Touch 3220 Clip4U</p> <p>23 24 24 25 26 26 26 27</p>							<p><b>Challenger</b></p> <p>2192 Clear 2597 Clear SG 2925 Clear MT 2418 Frosted 2416 Polished</p> <p>28 29 29 30 30</p>				
<p><b>Challenger</b></p> <p>2957 Polished Basic 2958 Polished Basic SG 2926 Polished MT 2737 Soft Touch 2927 Mix &amp; Match</p> <p>31 32 32 33 33</p>						<p><b>Super Hit</b></p> <p>2756 Clear 2234 Clear SG 2244 Frosted 2904 Matt 2883 Polished 2955 Polished Basic 2956 Polished Basic SG 2773 Mix &amp; Match</p> <p>34 34 35 35 36 36 37 37</p>						<p><b>Dart</b></p> <p>2602 Clear 2600 Polished 2959 Polished Basic</p> <p>38 38 39</p>						
<p><b>Big Pen</b></p> <p>2994 Polished Basic 2774 Mix &amp; Match</p> <p>39 40</p>		<p><b>Point</b></p> <p>3217 Polished 2866 Metal</p> <p>41 41</p>		<p><b>Hatrix</b></p> <p>2339 Clear SG 2419 Clear SG MC 3200 Polished Basic SG 3201 Polished Basic SG MC</p> <p>42 42 43 43</p>				<p><b>New Spring</b></p> <p>2410 Clear MC 2310 Polished MC</p> <p>44 44</p>		<p><b>Soft Spring</b></p> <p>2067 Polished</p> <p>45</p>	<p><b>Duo Pen</b></p> <p>2122 Polished</p> <p>45</p>							

**METAL PENS**

**Phenix**



**Arctic**



**Arvent**



**Attract**

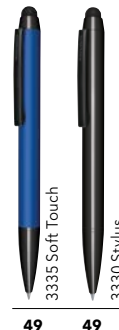

**Polar**



**Galant**



**Star Tec**



**Delgado**



**Nautic**



**Image**



**Signer  
Liner**



**Carbon Line**



**Tizio**



**CASES**

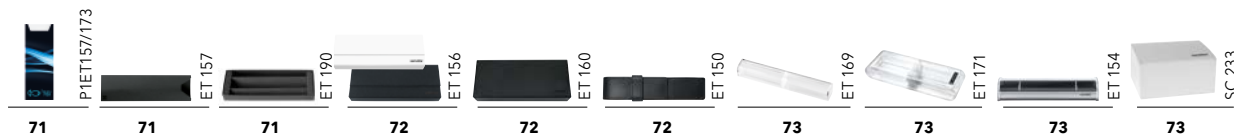

**SERVICES**

Branding  
Methods  
**104 - 105**

Refills  
**106**

**PRICE INFORMATION**

Article prices  
**On each product page**

Print prices  
**113**

# OUR MUGS

## OUTDOOR

King Can

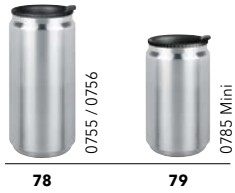

Trophy



Outdoor



## MUGS

Elegant



Elite



Amity



Maxim

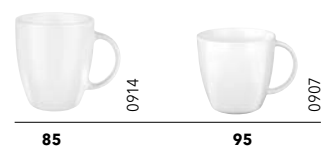

Pics Solid



Cosmos



Charisma

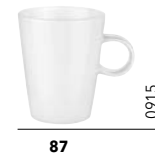

Appeal



Pics One



Maxi Mug



Pics Mini



Pics Two



Cult



Classic



Prime

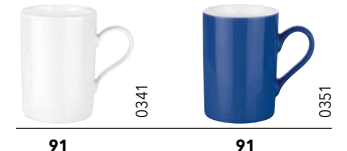

## SETS

Fancy

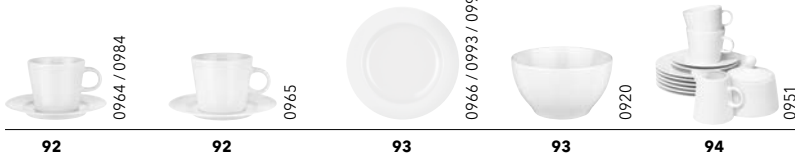

Maxim

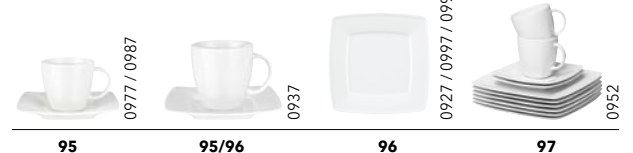

## SERVICES

Packaging	Branding Methods
98 - 99	108 - 109

## PRICE INFORMATION

Article prices	Print prices
On each product page	113



## OUR NOTEBOOKS

The senator® notebooks are practical companions in daily life. Handy in size, functional in design with pleasant soft surfaces. The customer logo can be printed or embossed with sufficient space on the front or back. And of course, your individually selected writing instrument can be easily accommodated in each of these books.



## SERVICES

Branding  
Methods

107

## PRICE INFORMATION

Article prices

On each product page

Druckpreise

113





## SENATOR PLASTIC PENS

**100 % MADE IN GERMANY.  
100 % SUSTAINABLE.  
100 % SUCCESS.**

senator® writing instruments have been produced in the heart of Germany for 100 years. Durability, sustainability and reliability are what drive us. For your advertising success.

## SUSTAINABLE PRODUCTION

Our environment is very close to our hearts. That is why our materials and production processes are geared towards sustainability, ecological compatibility, waste avoidance, resource conservation and recycling.

Our production takes place in the heart of Europe. This means short distances on the way to your customers.

## DURABILITY

We place the highest value on the use of first-class materials and high-quality workmanship.

The advertising application also meets high quality requirements: high colour brilliance, sharp-edged prints, long durability.



## GREEN ENERGY

We only purchase green electricity from hydropower and also invest in further electricity-saving measures at the production site.



## REFILLS

Our refills offer up to 5,000 m of writing comfort. No smearing or scratching, document-proof!

Once they are empty, you can get a **free replacement** at [www.refills.senator.com](http://www.refills.senator.com).



# BIOBASED PLASTICS AND RECYCLED PLASTICS

Plastic is a valuable resource but it should be used efficiently, which is why our materials and production processes are designed to be free of harmful substances, ecologically compatible, waste avoiding and recyclable. Close to 100% of our production waste is either reused or recycled.

Brand new in the range, you will now find three ball pen models made from post-industrial recycled material.

Our Bio range, however, goes even further. The visible parts of our Nature Plus, Skeye Bio and the barrel of our Super Hit Bio and Liberty Bio pens are made from a bioplastic which is based on PLA - derived from renewable and non-finite raw materials. Since 2019, our bio pens are completely climate neutral.



## BIOBASED PLASTICS (PLA UND R-PLA)

We use a PLA based on renewable resources for our bio products.

Our PLA is made from sugar cane. One of the most efficient raw materials for PLA production.



## RECYCLED PLASTICS (R-ABS)

We use an ABS recompond based on >95% recycled material.

This means reusing industrial production remnants and waste, returns and everyday products.

Source	Renewable raw material with a biobasis
Material basis	PLA (poly lactic acid from sugar cane)
Core characteristics	Pleasant feel and natural colours
CO <sub>2</sub> footprint	CO <sub>2</sub> reduced, as up to 85 % is organic / renewable



Genuinely recycled plastic from durable articles
ABS (Thermoplastic material)
High-quality surfaces
Up to 75 % less CO <sub>2</sub> compared to new ABS plastic



## EVOXX POLISHED RECYCLED

# UNMISTAKABLE RECYCLING HERO.

Made from recycled material, focused on durability and in a forward-looking, unique design that catches everyone's eye. For impressive advertising impact.



## EVOXX POLISHED RECYCLED

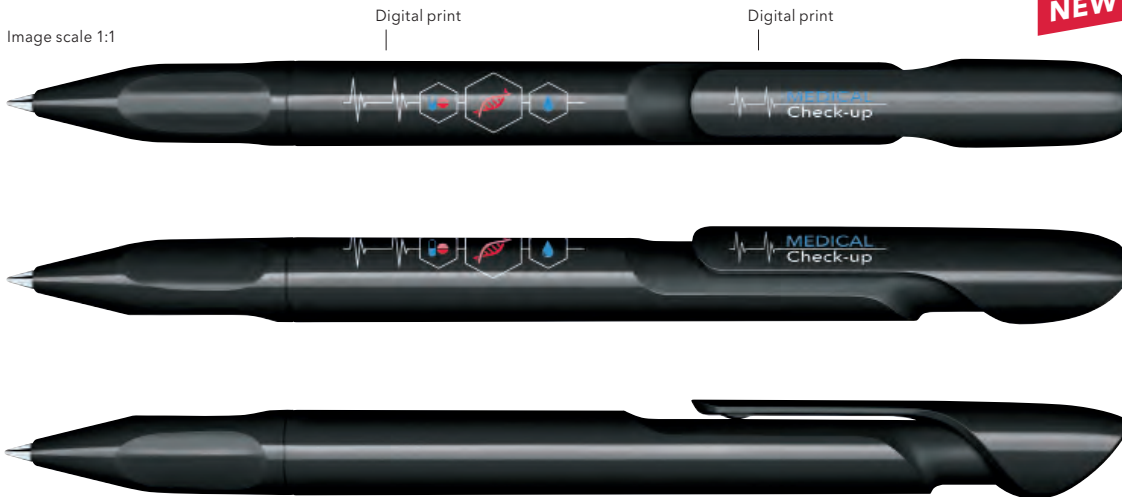

Your desired PMS colour available from 20,000 pieces  
Surcharge 1.000 €



Each Evoxx Recycled ball pen is marked "Recycled Material" on the back. Alternative imprints are possible by selecting printing area 4 - standard print.

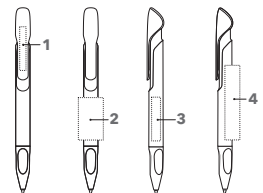

### ART. NO. 3273

#### Push ball pen with visible parts made from recycled material

Glossy opaque barrel, durable senator® magic flow G2 refill (1.0 mm), writing length up to 5,000 m, Ink colour: blue or black

Please note that recycled material may show slight colour variations.

#### SERVICES

**PMS Service:** from 20,000 pieces, see page 101

### INDUSTRIAL PRICES (€/PC.)

RSP in euro, per piece, VAT not included.

3273	500	1,000	2,500	5,000
Plain	0.43	0.40	0.38	0.36
Incl. 1c standard print, 1 position	0.63	0.55	0.50	0.47
Each further colour	0.20	0.15	0.12	0.11
Incl. digital print (CMYK), 1 motif	0.78	0.70	0.65	0.62

For branding prices please refer to page 113

### BRANDING / AREA

Clip	1	Standard print	35 x 5 mm
		Digital print	35 x 7 mm
Barrel	2	Standard print	34 x 20 mm
		Standard print (from 1,000 pieces)	40 x 35.5 mm
	3	Digital print	35 x 7 mm
	4	Standard print (from 1,000 pieces)	70 x 18 mm



## TRENTO MATT RECYCLED

### SUSTAINABLE SMART RECYCLING POWER.

The writing instrument focuses entirely on three plastic parts made of recycled material. The mechanism does not need any other parts. An entirely clever and sustainable strategy.

## TRENTO MATT RECYCLED

Image scale 1:1



Digital print

NEW



Your desired PMS colour available from 20,000 pieces (Surcharge 1,000 €)



Recycled Material

Each Trento Recycled ball pen is marked "Recycled Material" on the side. Alternative imprints are possible by selecting printing area 5- standard print.

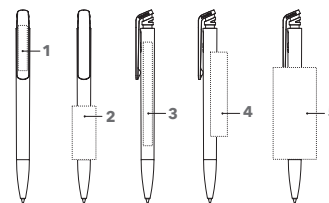

#### ART. NO. 3305

##### Push ball pen with visible parts made from recycled material

Matt opaque barrel, durable senator® magic flow X20 refill (1,0 mm), Ink colour: blue or black

Please note that recycled material may show slight colour variations.

#### SERVICES

PMS Service: from 20,000 pieces, see page 101

#### INDUSTRIAL PRICES (€/PC.)

RSP in euro, per piece, VAT not included.

3305	500	1,000	2,500	5,000
Plain	0.40	0.38	0.36	0.34
Incl. 1c standard print, 1 position	0.60	0.53	0.48	0.45
Each further colour	0.20	0.15	0.12	0.11
Incl. digital print (CMYK), 1 motif	0.75	0.68	0.63	0.60

For branding prices please refer to page 113

#### BRANDING / AREA

Clip	1	Standard print	35 x 6 mm
		Digital print	35 x 7 mm
Barrel	2	Standard print	45 x 20 mm
	3	Digital print	80 x 7 mm
	4	Standard print	65 x 13 mm
	5	Standard print	60 x 30 mm
		(from 1,000 pieces)	



# CHALLENGER MATT RECYCLED

**NEW**

Image scale 1:1



Your desired PMS colour available from 20,000 pieces (Surcharge 1,000 €)



Recycled Material

Each Challenger Recycled ball pen is marked "Recycled Material" on the back. Alternative imprints are possible by selecting printing area 5 - standard print.

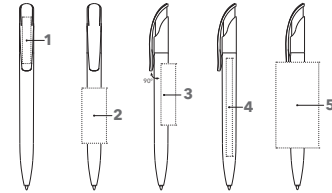

## ART. NO. 3402

### Push ball pen, sichtbare Teile aus Recycling-Material

Matt opaque body surface, durable senator® magic flow G2 refill (1.0 mm), writing length up to 5,000 m, Ink colour: blue or black  
Please note that recycled material may show slight colour variations.

### SERVICES

**Mix & Match:** see page 100

**PMS Service:** from 20,000 pieces, see page 101

**NFC function:** see page 103

## INDUSTRIAL PRICES (€/PC.)

RSP in euro, per piece, VAT not included.

3402	500	1,000	2,500	5,000
Plain	0.53	0.50	0.48	0.47
Incl. 1c standard print, 1 position	0.73	0.65	0.60	0.58
Each further colour	0.20	0.15	0.12	0.11
Incl. digital print (CMYK), 1 motif	0.88	0.80	0.75	0.73

For branding prices please refer to page 113

## BRANDING / AREA

Clip	1	Standard print	35 x 7 mm or 40 x 5 mm
		Digital print	35 x 7 mm
Barrel	2	Standard print	45 x 20 mm
	3	Standard print	50 x 12 mm
	4	Digital print	80 x 7 mm
	5	Standard print (from 1,000 pieces)	60 x 35 mm



# CHALLENGER MATT RECYCLED MIX & MATCH

**NEW**

Image scale 1:1



**Barrel**  
Matt  
4 colours

**Upper**  
Matt  
15 standard colours

**Clip**  
Matt  
4 colours

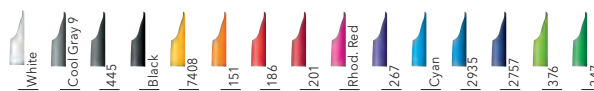
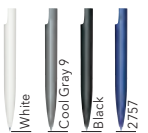

## ART. NO. 3403

### Push ball pen with visible parts made from recycled material

Free combination option of 4 colours for barrel and clip and 15 colours for the upper for an individual match to your corporate design.

Durable senator® magic flow G2 refill (1.0 mm), writing length up to 5,000 m, Ink colour: blue or black

Please note that recycled material may show slight colour variations.

## INDUSTRIAL PRICES (€/PC.)

RSP in euro, per piece, VAT not included.

3403	1,000	2,500	5,000
Plain	0.53	0.51	0.50
Incl. 1c standard print, 1 position	0.68	0.63	0.61
Each further colour	0.15	0.12	0.11
Incl. digital print (CMYK), 1 motif	0.83	0.78	0.76

For branding prices please refer to page 113

## BRANDING / AREA

See Challenger Matt Recycled, Art. No. 3402

### SERVICES

**Mix & Match:** see page 100

**PMS Service:** from 20,000 pieces, see page 101

**NFC function:** see page 103



## LIBERTY BIO

# TOP DESIGN WITH BIOPLASTICS.

A thoroughly durable concept: bio-based plastic, replaceable refill and trendy look. Environmental awareness hand in hand with good design.



## LIBERTY BIO

Image scale 1:1

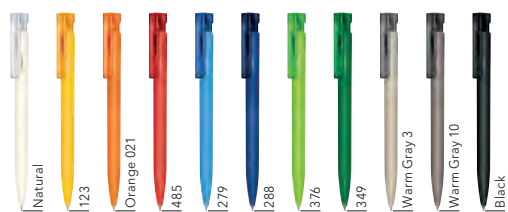
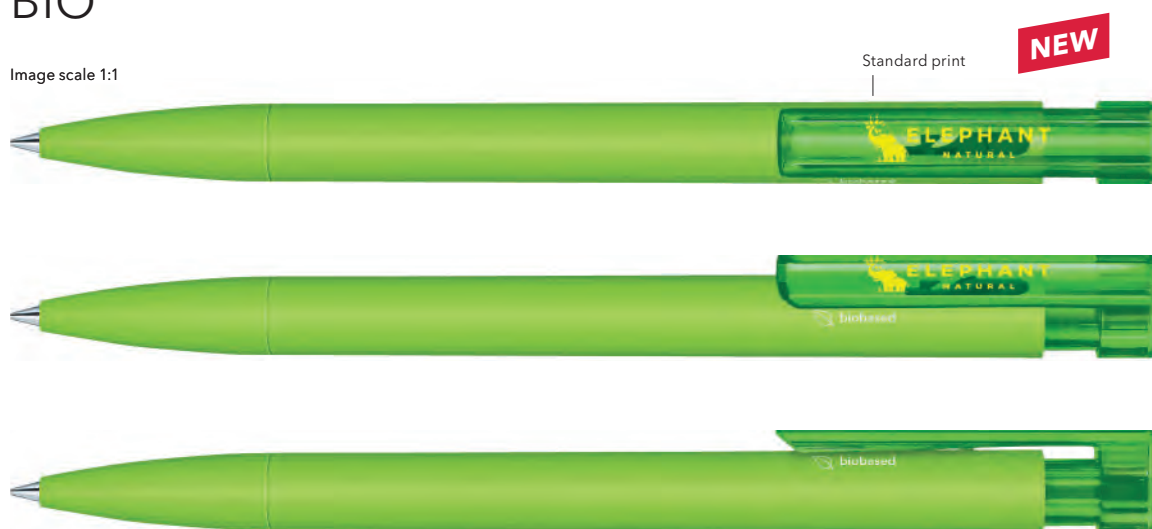

Your desired PMS colour available from 20,000 pieces (Surcharge 1,000 €)

Standard print

NEW

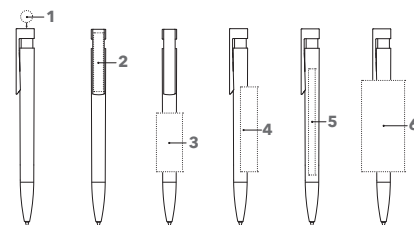

### ART. NO. 3310

#### Push ball pen

Barrel and tip: bio-based material, matt surface, glossy transparent mid and clip surface, senator® magic flow G2 refill (1.0 mm) ink colour: blue or black

Note:

The surface of products made of bio plastics may show slight irregularities.

#### SERVICES

**PMS Service:** from 20,000 pieces, see page 101  
**Express Service (Online Portal):** see page 102

### INDUSTRIAL PRICES (€/PC.)

RSP in euro, per piece, VAT not included.

3310	500	1,000	2,500	5,000
Plain	0.49	0.47	0.44	0.41
Incl. 1c standard print, 1 position	0.69	0.62	0.56	0.52
Each further colour	0.20	0.15	0.12	0.11
Incl. digital print (CMYK), 1 motif	0.84	0.77	0.71	0.67

For branding prices please refer to page 113

### BRANDING / AREA

Part	Branding	Area
Cap	1 Digital print	Ø 9.5 mm
Clip	2 Standard print	40 x 6 mm
	Digital print	35 x 7 mm
Barrel	3 Standard print	45 x 20 mm
	4 Standard print	65 x 13 mm
	5 Digital print	80 x 7 mm
	6 Standard print (from 1,000 pieces)	60 x 30 mm



## SKEYE BIO

# SUSTAINABLE ADVERTISING WITH BIOPLASTICS.

Renewable raw materials, sustainable production processes and a design that has won numerous awards create this unique bios for your environmentally conscious brand presentation.



## SKEYE BIO

Image scale 1:1

Standard print

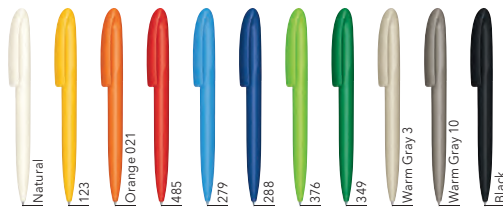

Your desired PMS colour available from 20,000 pieces (Surcharge 1,000 €)



As awarded by The Chicago Athenaeum Museum of Architecture and Design and The European Centre for Architecture Art Design and Urban Studies

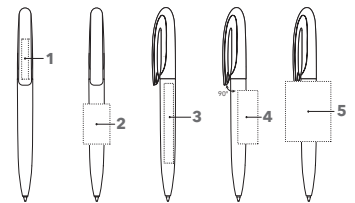

### ART. NO. 3290

#### Twist ball pen

bio-based material, matt surface, senator® magic flow G2 refill (1.0 mm) ink colour: blue or black

Note: The surface of products made of bio plastics may show slight irregularities.

#### SERVICES

**PMS Service:** from 20,000 pieces, see page 101  
**Express Service (Online Portal):** see page 102

### INDUSTRIAL PRICES (€/PC.)

RSP in euro, per piece, VAT not included.

3290	500	1,000	2,500	5,000
Plain	0.70	0.65	0.61	0.57
Incl. 1c standard print, 1 position	0.90	0.80	0.73	0.68
Each further colour	0.20	0.15	0.12	0.11
Incl. digital print (CMYK), 1 motif	1.05	0.95	0.88	0.83

For branding prices please refer to page 113

### BRANDING / AREA

Clip	1	Standard print	35 x 6 mm
Barrel	2	Standard print	30 x 20 mm
	3	Digital print	50 x 7 mm
	4	Standard print	40 x 15 mm
	5	Standard print (from 1,000 pieces)	45 x 34 mm



# SUPER HIT BIO

Image scale 1:1

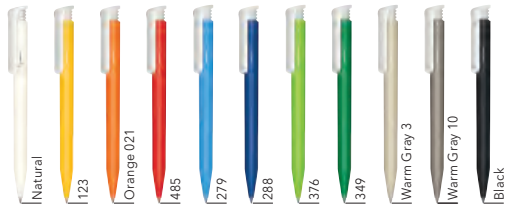

Your desired PMS colour available from 20,000 pieces (Surcharge 1,000 €)

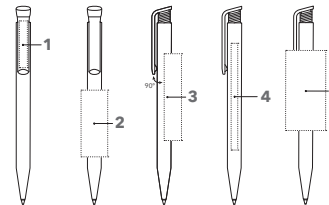

## ART. NO. 3300

### Push ball pen

Barrel: bio-based material, matt surface, clip pusher: polished opaque, white, senator® magic flow X20 refill (1.0 mm), ink colour: blue or black

Note: The surface of products made of bio plastics may show slight irregularities.

### SERVICES

**PMS Service:** from 20,000 pieces, see page 101  
**Express Service (Online Portal):** see page 102  
**5.000 in 5:** see page 102

## INDUSTRIAL PRICES (€/PC.)

RSP in euro, per piece, VAT not included.

3300	500	1.000	2.500	5.000
<b>Plain</b>	0.34	0.31	0.29	0.28
<b>Incl. 1c standard print, 1 position</b>	0.54	0.46	0.41	0.39
Each further colour	0.20	0.15	0.12	0.11
<b>Incl. digital print (CMYK), 1 motif</b>	0.69	0.61	0.56	0.54

For branding prices please refer to page 113

## BRANDING / AREA

Clip	1	Standard print	35 x 6 mm
		Digital print	35 x 7 mm
Barrel	2	Standard print	50 x 20 mm
	3	Standard print	65 x 13 mm
	4	Digital print	80 x 7 mm
	5	Standard print (from 1,000 pieces)	60 x 30 mm



# NATURE PLUS BIO

Image scale 1:1

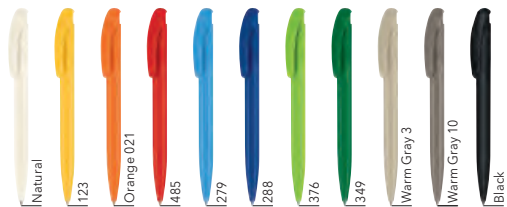

Your desired PMS colour available from 20,000 pieces (Surcharge 1,000 €)

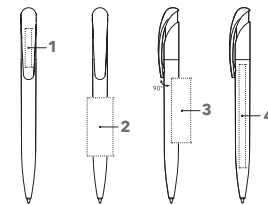

## ART. NO. 2796

### Push ball pen

bio-based material, matt surface, senator® magic flow G2 refill (1.0 mm), ink colour: blue or black

Note: The surface of products made of bio plastics may show slight irregularities.

### SERVICES

**PMS Service:** from 20,000 pieces, see page 101  
**Express Service (Online Portal):** see page 102

## INDUSTRIAL PRICES (€/PC.)

RSP in euro, per piece, VAT not included.

2796	500	1.000	2.500	5.000
<b>Plain</b>	0.70	0.65	0.61	0.57
<b>Incl. 1c standard print, 1 position</b>	0.90	0.80	0.73	0.68
Each further colour	0.20	0.15	0.12	0.11
<b>Incl. digital print (CMYK), 1 motif</b>	1.05	0.95	0.88	0.83

For branding prices please refer to page 113

## BRANDING / AREA

Clip	1	Standard print	30 x 5 mm
		Digital print	35 x 7 mm
Barrel	2	Standard print	45 x 20 mm
	3	Standard print	50 x 15 mm
	4	Digital print	80 x 7 mm





## SENATOR® ANTIBAC®

### BESTSELLERS NOW WITH ANTIBACTERIAL FINISH.

The senator® Antibac® range offers antibacterial and antiviral protection of the surface for the entire lifetime of the pen. Now available in three popular designs.



## CHALLENGER POLISHED ANTIBAC®

Image scale 1:1



15 senator® standard colours available from 20,000 pieces

Your desired PMS colour available from 20,000 pieces (Surcharge 1,000 €)

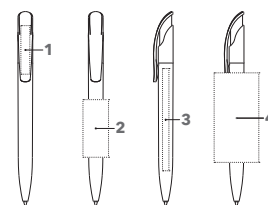

#### ART. NO. 3401

##### Retractable ball pen with antibacterial and antiviral surface

Plastic from Germany mixed with silver compounds, antibacterial effect confirmed by testing according to ISO 22196, antiviral effect according to ISO 21702. Polished opaque barrel surface, white barrel and clip, long lasting senator® magic flow G2 refill (1.0 mm), writing length up to 5,000 m  
Ink colour: blue or black

##### SERVICES

**PMS Service:** from 20,000 pieces, see page 101

**Express Service (Online Portal):** see page 102

**NFC function:** see page 103

#### INDUSTRIAL PRICES (€/PC.)

RSP in euro, per piece, VAT not included.

3401	500	1,000	2,500	5,000
<b>Plain</b>	0.51	0.48	0.47	0.45
<b>Incl. 1c standard print, 1 position</b>	0.71	0.63	0.59	0.56
Each further colour	0.20	0.15	0.12	0.11
<b>Incl. digital print (CMYK), 1 motif</b>	0.86	0.78	0.74	0.71

For branding prices please refer to page 113

#### BRANDING / AREA

Clip	1	Standard print	35 x 7 mm or 40 x 5 mm
		Digital print	35 x 7 mm
Barrel	2	Standard print	40 x 20 mm
	3	Digital print	80 x 7 mm
	4	Standard print	60 x 35 mm
		(from 1,000 pieces)	

# SUPER HIT POLISHED ANTIBAC®

**NEW**

Image scale 1:1

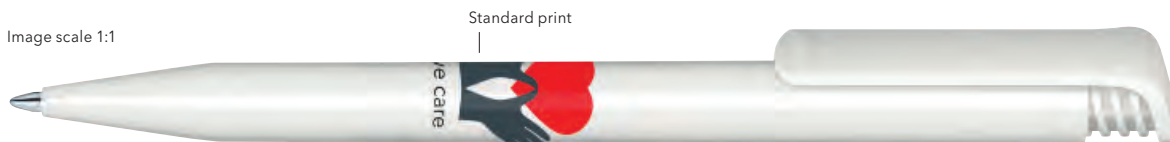

15 senator® standard colours available from 20,000 pieces

Your desired PMS colour available from 20,000 pieces (Surcharge 1,000 €)

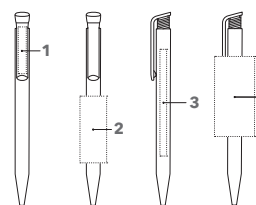

## ART. NO. 3306

### Retractable ball pen with antibacterial and antiviral surface

Plastic from Germany mixed with silver compounds, antibacterial effect confirmed by testing according to ISO 22196, antiviral effect according to ISO 21702. Polished opaque barrel surface, white barrel and clip, long lasting senator® magic flow X20 refill (1.0 mm), writing length up to 2,000 m  
Ink colour: blue or black

### SERVICES

**PMS Service:** from 20,000 pieces, see page 101  
**Express Service (Online Portal):** see page 102

## INDUSTRIAL PRICES (€/PC.)

RSP in euro, per piece, VAT not included.

3306	500	1,000	2,500	5,000
<b>Plain</b>	0.36	0.34	0.32	0.31
<b>Incl. 1c standard print, 1 position</b>	0.56	0.49	0.44	0.42
Each further colour	0.20	0.15	0.12	0.11
<b>Incl. digital print (CMYK), 1 motif</b>	0.71	0.64	0.59	0.57

For branding prices please refer to page 113

## BRANDING / AREA

Clip	1	Standard print	35 x 7 mm
		Digital print	35 x 7 mm
Barrel	2	Standard print	40 x 20 mm
	3	Digital print	80 x 7 mm
	4	Standard print	60 x 30 mm (from 1,000 pieces)

# LIBERTY POLISHED BASIC ANTIBAC®

**NEW**

Image scale 1:1

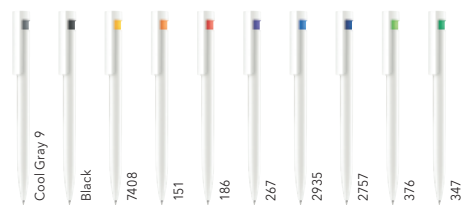
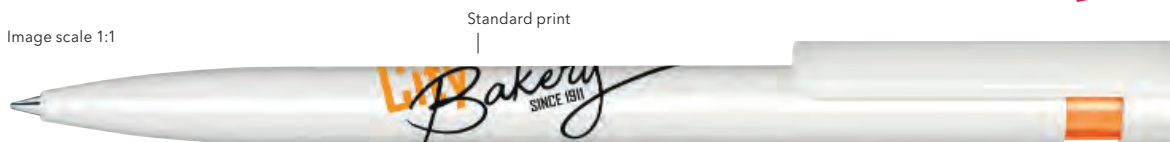

15 senator® standard colours available from 20,000 pieces

Your desired PMS colour available from 20,000 pieces (Surcharge 1,000 €)

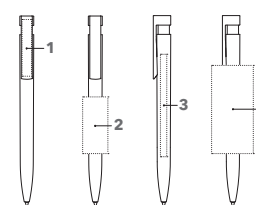

## ART. NO. 3407

### Retractable ball pen with antibacterial surface

Plastic from Germany mixed with silver compounds, antibacterial effect confirmed by testing according to ISO 22196, antiviral effect according to ISO 21702. Polished opaque barrel surface, white barrel and clip, coloured mid, long lasting senator® magic flow G2 refill (1.0 mm), writing length up to 5,000 m  
Ink colour: black

### SERVICES

**PMS Service:** from 20,000 pieces, see page 101  
**Express Service (Online Portal):** see page 102

## INDUSTRIAL PRICES (€/PC.)

RSP in euro, per piece, VAT not included.

3407	500	1,000	2,500	5,000
<b>Plain</b>	0.47	0.45	0.42	0.39
<b>Incl. 1c standard print, 1 position</b>	0.67	0.60	0.54	0.50
Each further colour	0.20	0.15	0.12	0.11
<b>Incl. digital print (CMYK), 1 motif</b>	0.82	0.75	0.69	0.65

For branding prices please refer to page 113

## BRANDING / AREA

Clip	1	Standard print	35 x 7 mm
		Digital print	35 x 7 mm
Barrel	2	Standard print	40 x 20 mm
	3	Digital print	80 x 7 mm
	4	Standard print	60 x 33 mm (from 1,000 pieces)

## HEADLINER SOFT TOUCH

### ELEGANT DESIGN. PURE CHARACTER.

Elegant, linear design meets extraordinary advertising space for maximum promotional success. Convincing in look and feel. A real delight in the hand.



## HEADLINER SOFT TOUCH

Image scale 1:1

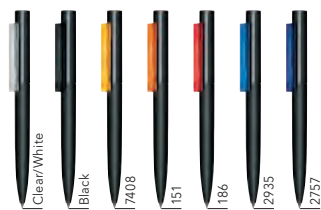

Your desired PMS colour available from 20,000 pieces (Surcharge 1,000 €)

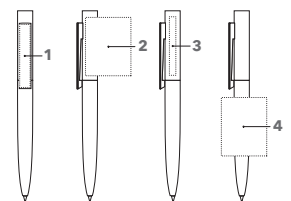

#### ART. NO. 3285

##### Twist ball pen

Polished upper, barrel with velvety surface, clear clip, senator® magic flow G2 refill (1.0 mm) ink colour: blue or black

##### SERVICES

**PMS Service:** from 20,000 pieces, see page 101

#### INDUSTRIAL PRICES (€/PC.)

RSP in euro, per piece, VAT not included.

3285	500	1,000	2,500	5,000
<b>Plain</b>	1.22	1.16	1.08	1.03
<b>Incl. 1c standard print, 1 position</b>	1.42	1.31	1.20	1.14
Each further colour	0.20	0.15	0.12	0.11
<b>Incl. digital print (CMYK), 1 motif</b>	1.57	1.46	1.35	1.29

For branding prices please refer to page 113

#### BRANDING / AREA

Clip	1	Digital print	48.5 x 8 mm
		Standard print	40 x 6 mm
Upper	2	Standard print (from 1,000 pieces)	45 x 35 mm
	3	Standard print	45 x 5 mm
Barrel	4	Standard print (from 1,000 pieces)	45 x 34.5 mm

# HEADLINER CLEAR BASIC

Image scale 1:1

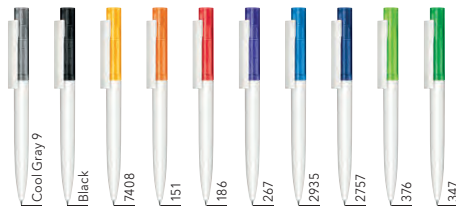

Your desired PMS colour available from 20,000 pieces (Surcharge 1,000 €)

Digital print

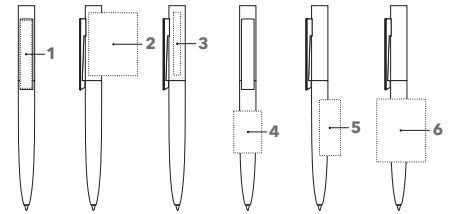

## ART. NO. 3281

### Twist ball pen

Polished opaque barrel surface mixed with glossy transparent upper surface, polished white clip  
senator® magic flow G2 refill (1.0 mm).  
ink colour: blue or black

### SERVICES

**PMS Service:** from 20,000 pieces, see page 101  
**5.000 in 5:** see page 102

## INDUSTRIAL PRICES (€/PC.)

RSP in euro, per piece, VAT not included.

	500	1.000	2.500	5.000
<b>3281</b>				
<b>Plain</b>	0.69	0.66	0.62	0.60
<b>Incl. 1c standard print, 1 position</b>	0.89	0.81	0.74	0.71
Each further colour	0.20	0.15	0.12	0.11
<b>Incl. digital print (CMYK), 1 motif</b>	1.04	0.96	0.89	0.86

For branding prices please refer to page 113

## BRANDING / AREA

<b>Clip</b>	1	Digital print	48.5 x 8 mm
		Standard print	40 x 6 mm
<b>Upper</b>	2	Standard print	45 x 35 mm
	3	Standard print	45 x 5 mm
<b>Barrel</b>	4	Standard print	30 x 20 mm
	5	Standard print	40 x 15 mm
	6	Standard print (from 1,000 pieces)	45 x 34.5 mm
		Digital print (from 1,000 pieces)	45 x 34 mm

# HEADLINER POLISHED BASIC

Image scale 1:1

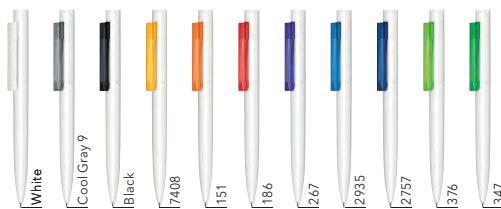

Your desired PMS colour available from 20,000 pieces (Surcharge 1,000 €)

Standard print

Digital print

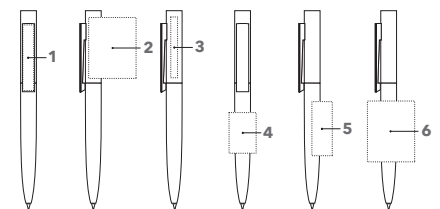

## ART. NO. 3280

### Twist ball pen

Polished opaque barrel surface, polished white or transparent coloured clip,  
senator® magic flow G2 refill (1.0 mm)  
ink colour: blue or black

### SERVICES

**PMS Service:** from 20,000 pieces, see page 101  
**5.000 in 5:** see page 102

## INDUSTRIAL PRICES (€/PC.)

RSP in euro, per piece, VAT not included.

	500	1.000	2.500	5.000
<b>3280</b>				
<b>Plain</b>	0.67	0.64	0.60	0.58
<b>Incl. 1c standard print, 1 position</b>	0.87	0.79	0.72	0.69
Each further colour	0.20	0.15	0.12	0.11
<b>Incl. digital print (CMYK), 1 motif</b>	1.02	0.94	0.87	0.84

For branding prices please refer to page 113

## BRANDING / AREA

<b>Clip</b>	1	Digital print	48.5 x 8 mm
		Standard print	40 x 6 mm
<b>Upper</b>	2	Standard print (from 1,000 pieces)	45 x 35 mm
		Digital print (from 1,000 pieces)	52.8 x 35.6 mm
<b>Barrel</b>	3	Standard print	45 x 5 mm
	4	Standard print	30 x 20 mm
	5	Standard print	40 x 15 mm
	6	Standard print (from 1,000 pieces)	45 x 34.5 mm
	Digital print (from 1,000 pieces)	45 x 34 mm	

# BRIDGE CLEAR

Image scale 1:1



Your desired PMS colour available from 20,000 pieces (Surcharge 1,000 €)

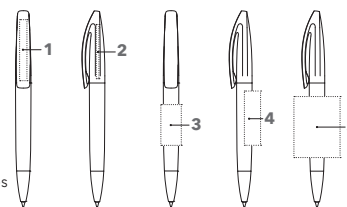

## ART. NO. 3251

### Twist ball pen

Glossy transparent body and clip surface, senator® magic flow G2 refill (1.0 mm) ink colour: blue or black

### SERVICES

Mix & Match: see page 100

PMS Service: from 20,000 pieces, see page 101

Express Service (Online Portal): see page 102

5.000 in 5: see page 102

## INDUSTRIAL PRICES (€/PC.)

RSP in euro, per piece, VAT not included.

3251	500	1,000	2,500	5,000
Plain	0.60	0.57	0.53	0.51
Incl. 1c standard print, 1 position	0.80	0.72	0.65	0.62
Each further colour	0.20	0.15	0.12	0.11
Incl. digital print (CMYK), 1 motif	0.95	0.87	0.80	0.77

For branding prices please refer to page 113

## BRANDING / AREA

Clip	1	Standard print	45 x 5 mm or 35 x 8 mm
		Digital print	35 x 7 mm
Upper	2	Standard print	40 x 2 mm or 30 x 3 mm
Barrel	3	Standard print	30 x 15 mm
	4	Standard print	40 x 12 mm
	5	Standard print (from 1,000 pieces)	45 x 34 mm

# BRIDGE CLEAR MT

Image scale 1:1



Your desired PMS colour available from 20,000 pieces (Surcharge 1,000 €)

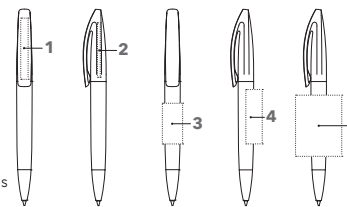

## ART. NO. 3253

### Twist ball pen

Glossy transparent body and clip surface, glossy metal tip, senator® magic flow G2 refill (1.0 mm) ink colour: blue or black

### SERVICES

Mix & Match: see page 100

PMS Service: from 20,000 pieces, see page 101

## INDUSTRIAL PRICES (€/PC.)

RSP in euro, per piece, VAT not included.

3253	500	1,000	2,500	5,000
Plain	0.82	0.79	0.75	0.73
Incl. 1c standard print, 1 position	1.02	0.94	0.87	0.84
Each further colour	0.20	0.15	0.12	0.11
Incl. digital print (CMYK), 1 motif	1.17	1.09	1.02	0.99

For branding prices please refer to page 113

## BRANDING / AREA

Clip	1	Standard print	45 x 5 mm or 35 x 8 mm
		Digital print	35 x 7 mm
Upper	2	Standard print	40 x 2 mm or 30 x 3 mm
Barrel	3	Standard print	30 x 15 mm
	4	Standard print	40 x 12 mm
	5	Standard print (from 1,000 pieces)	45 x 34 mm

# BRIDGE POLISHED

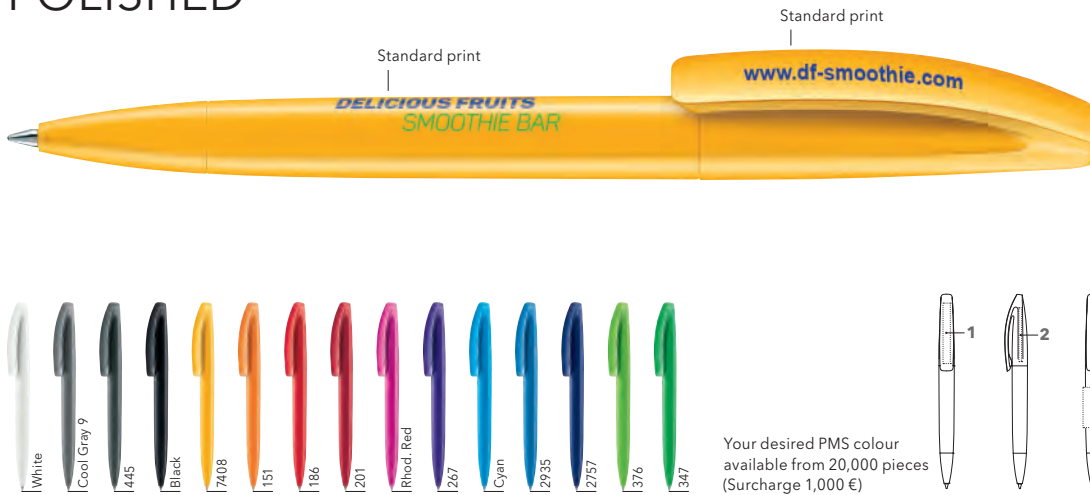

## ART. NO. 3250

### Twist ball pen

Glossy opaque body and clip surface, senator® magic flow G2 refill (1.0 mm) ink colour: blue or black

### SERVICES

**Mix & Match:** see page 100

**PMS Service:** from 20,000 pieces, see page 101

**Express Service (Online Portal):** see page 102

**5.000 in 5:** see page 102

## INDUSTRIAL PRICES (€/PC.)

RSP in euro, per piece, VAT not included.

3250	500	1,000	2,500	5,000
<b>Plain</b>	0.58	0.55	0.51	0.49
<b>Incl. 1c standard print, 1 position</b>	0.78	0.70	0.63	0.60
Each further colour	0.20	0.15	0.12	0.11
<b>Incl. digital print (CMYK), 1 motif</b>	0.93	0.85	0.78	0.75

For branding prices please refer to page 113

## BRANDING / AREA

<b>Clip</b>	<b>1</b>	Standard print	45 x 5 mm or 35 x 8 mm
		Digital print	35 x 7 mm
<b>Upper</b>	<b>2</b>	Standard print	40 x 2 mm or 30 x 3 mm
<b>Barrel</b>	<b>3</b>	Standard print	30 x 15 mm
		Standard print	40 x 12 mm
	<b>4</b>	Standard print	45 x 34 mm
		Digital print on white barrel (from 1,000 pieces)	65.5 x 34.5 mm
	<b>5</b>	Standard print (from 1,000 pieces)	

# BRIDGE POLISHED MT

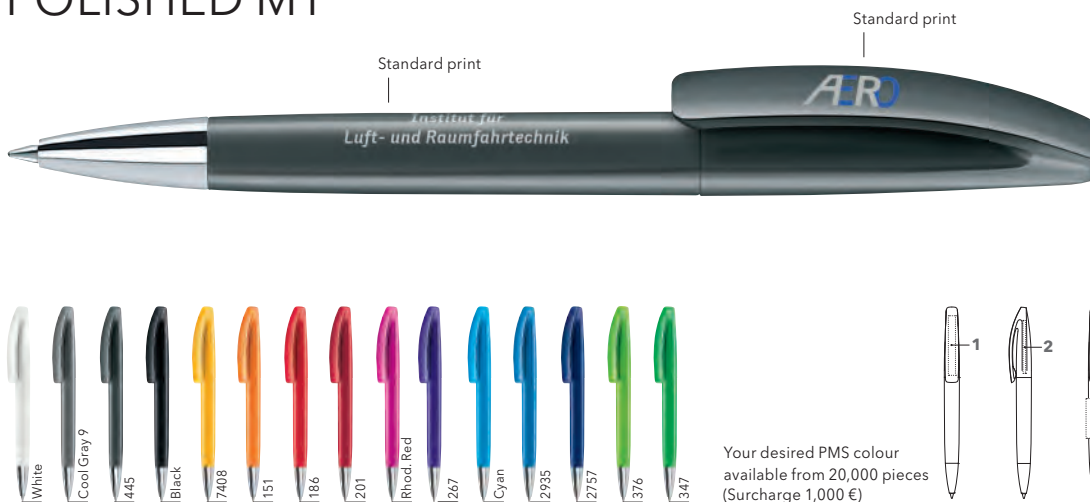

## ART. NO. 3252

### Twist ball pen

Glossy opaque body and clip surface, glossy metal tip, senator® magic flow G2 refill (1.0 mm) ink colour: blue or black

### SERVICES

**Mix & Match:** see page 100

**PMS Service:** from 20,000 pieces, see page 101

**Express Service (Online Portal):** see page 102

## INDUSTRIAL PRICES (€/PC.)

RSP in euro, per piece, VAT not included.

3252	500	1,000	2,500	5,000
<b>Plain</b>	0.80	0.77	0.73	0.71
<b>Incl. 1c standard print, 1 position</b>	1.00	0.92	0.85	0.82
Each further colour	0.20	0.15	0.12	0.11
<b>Incl. digital print (CMYK), 1 motif</b>	1.15	1.07	1.00	0.97

For branding prices please refer to page 113

## BRANDING / AREA

<b>Clip</b>	<b>1</b>	Standard print	45 x 5 mm or 35 x 8 mm
		Digital print	35 x 7 mm
<b>Upper</b>	<b>2</b>	Standard print	40 x 2 mm or 30 x 3 mm
<b>Barrel</b>	<b>3</b>	Standard print	30 x 15 mm
		Standard print	40 x 12 mm
	<b>4</b>	Standard print	45 x 34 mm
		Digital print on white barrel (from 1,000 pieces)	65.5 x 34.5 mm
	<b>5</b>	Standard print (from 1,000 pieces)	

# BRIDGE SOFT TOUCH

Image scale 1:1



Your desired PMS colour  
available from 20,000 pieces  
(Surcharge 1,000 €)

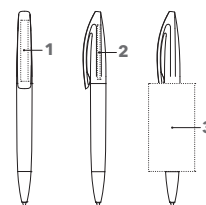

## ART. NO. 3257

### Twist ball pen

Velvety matt surface,  
senator® magic flow G2 refill (1.0 mm)  
ink colour: blue or black

### SERVICES

**PMS Service:** from 20,000 pieces, see page 101

## INDUSTRIAL PRICES (€/PC.)

RSP in euro, per piece, VAT not included.

3257	500	1,000	2,500	5,000
<b>Plain</b>	1.28	1.15	1.06	1.04
<b>Incl. 1c standard print, 1 position</b>	1.48	1.30	1.18	1.15
Each further colour	0.20	0.15	0.12	0.11

For branding prices please refer to page 113

## BRANDING / AREA

Clip	1	Standard print	45 x 5 mm or 35 x 8 mm
<b>Upper</b>	2	Standard print	40 x 2 mm or 30 x 3 mm
<b>Barrel</b>	3	Standard print (from 1,000 pieces)	45 x 34 mm

# BRIDGE MIX & MATCH

Image scale 1:1

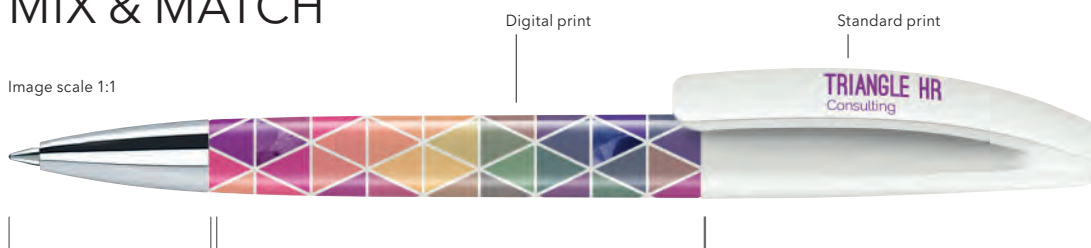

**Tip**  
Polished  
Clear  
Metal

15 standard colours  
15 standard colours  
glossy silver

**Barrel**  
Polished  
Clear

15 standard colours  
15 standard colours

**Cap**  
Polished  
Clear

15 standard colours  
15 standard colours

## ART. NO. 3256

### Twist ball pen

Free combination option of different parts,  
surfaces and colours.  
senator® magic flow G2 refill (1.0 mm)  
ink colour: blue or black

### SERVICES

**Mix & Match:** see page 100  
**PMS Service:** from 20,000 pieces, see page 101  
**Additional refill option:**  
senator® magic flow G2 refill (1.4 mm).  
see page 106

## INDUSTRIAL PRICES (€/PC.)

RSP in euro, per piece, VAT not included.

3256	1,000	2,500	5,000
<b>Plain</b>	0.60	0.56	0.54
<b>Incl. 1c standard print, 1 position</b>	0.75	0.68	0.65
Each further colour	0.15	0.12	0.11
<b>Incl. digital print (CMYK), 1 motif</b>	0.90	0.83	0.80
<b>Surcharge metal tip</b>	0.22	0.22	0.22
<b>Surcharge magic flow refill 1.4</b>	0.08	0.08	0.08

For branding prices please refer to page 113

## BRANDING / AREA

Please see the Bridge models used for the  
branding areas on those parts or contact us.

## LIBERTY CLEAR

### MODERN DESIGN WITH A CLEAR MESSAGE.

Design in its purest form: Offers the perfect setting for self-confident advertising with its purist design language and glossy colour selection. Long live your creativity.



## LIBERTY CLEAR

Image scale 1:1

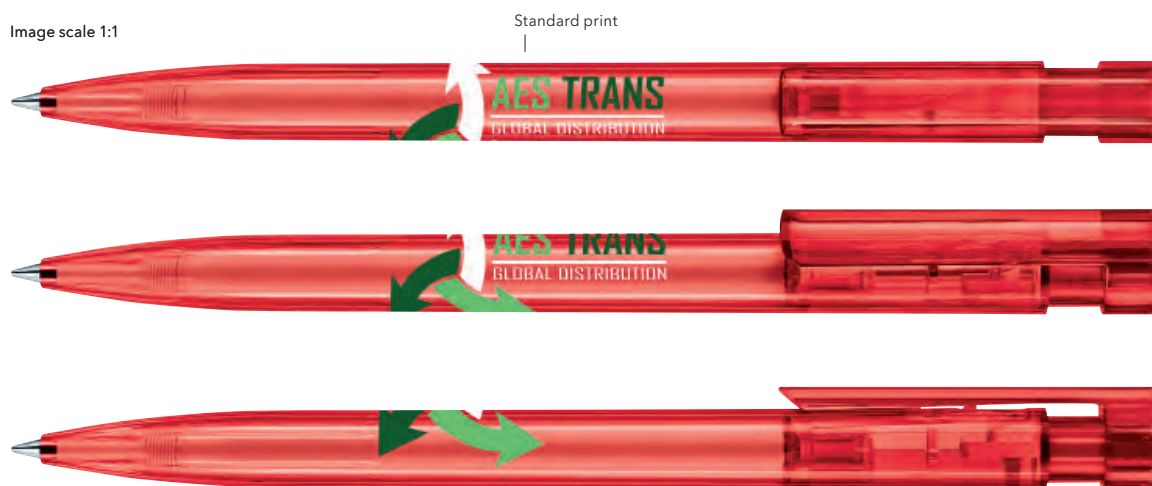

Your desired PMS colour  
available from 20,000 pieces  
(Surcharge 1,000 €)

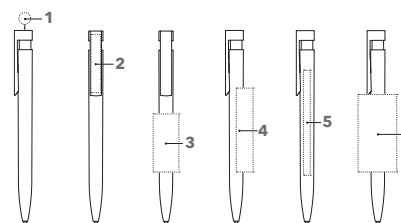

#### ART. NO. 2983

##### Push ball pen

Glossy transparent body and clip surface,  
senator® magic flow G2 refill (1.0 mm)  
ink colour: blue or black

##### SERVICES

**Mix & Match:** see page 100

**PMS Service:** from 20,000 pieces, see page 101

**5.000 in 5:** see page 102

#### INDUSTRIAL PRICES (€/PC.)

RSP in euro, per piece, VAT not included.

2983	500	1.000	2.500	5.000
Plain	0.39	0.37	0.34	0.31
Incl. 1c standard print, 1 position	0.59	0.52	0.46	0.42
Each further colour	0.20	0.15	0.12	0.11
Incl. digital print (CMYK), 1 motif	0.74	0.67	0.61	0.57

For branding prices please refer to page 113

#### BRANDING / AREA

Cap	1	Digital print	Ø 9.5 mm
Clip	2	Standard print	40 x 6 mm
		Digital print	35 x 7 mm
Barrel	3	Standard print	45 x 20 mm
	4	Standard print	65 x 13 mm
	5	Digital print	80 x 7 mm
	6	Standard print (from 1,000 pieces)	60 x 30 mm



# LIBERTY POLISHED

Image scale 1:1



Standard print

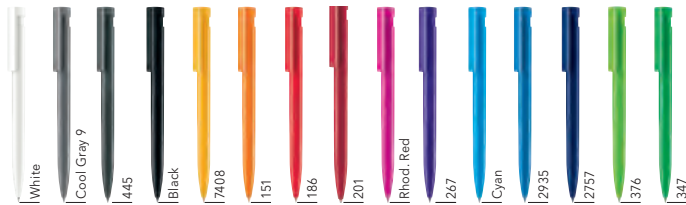

Your desired PMS colour available from 20,000 pieces (Surcharge 1,000 €)

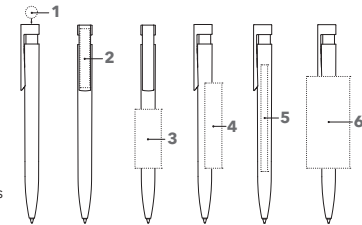

## ART. NO. 2915

### Push ball pen

Glossy opaque body and clip surface, senator® magic flow G2 refill (1.0 mm) ink colour: blue or black

### SERVICES

**Mix & Match:** see page 100

**PMS Service:** from 20,000 pieces, see page 101

**Express Service (Online Portal):** see page 102

**5.000 in 5:** see page 102

## INDUSTRIAL PRICES (€/PC.)

RSP in euro, per piece, VAT not included.

2915	500	1,000	2,500	5,000
<b>Plain</b>	0.37	0.35	0.32	0.29
<b>Incl. 1c standard print, 1 position</b>	0.57	0.50	0.44	0.40
Each further colour	0.20	0.15	0.12	0.11
<b>Incl. digital print (CMYK), 1 motif</b>	0.72	0.65	0.59	0.55

For branding prices please refer to page 113

## BRANDING / AREA

Cap	1	Digital print	Ø 9.5 mm
Clip	2	Standard print	40 x 6 mm
		Digital print	35 x 7 mm
Barrel	3	Standard print	45 x 20 mm
		Standard print	65 x 13 mm
	5	Digital print	80 x 7 mm
		Standard print (from 1,000 pieces)	60 x 30 mm
	6	Digital print on white barrel (from 1,000 pieces)	70 x 33 mm

# LIBERTY POLISHED BASIC

Image scale 1:1



Digital print

Standard print

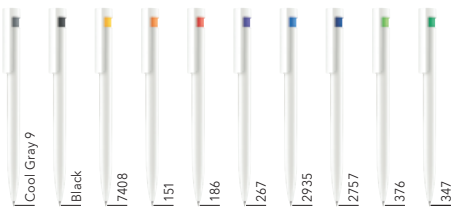

Your desired PMS colour available from 20,000 pieces (Surcharge 1,000 €)

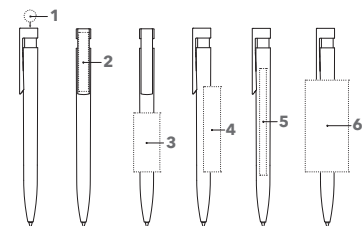

## ART. NO. 2993

### Push ball pen

Glossy opaque white barrel and clip surface, coloured transparent mid part, senator® magic flow G2 refill (1.0 mm) ink colour: blue or black

### SERVICES

**Mix & Match:** see page 100

**PMS Service:** from 20,000 pieces, see page 101

**Express Service (Online Portal):** see page 102

**5.000 in 5:** see page 102

## INDUSTRIAL PRICES (€/PC.)

RSP in euro, per piece, VAT not included.

2993	500	1,000	2,500	5,000
<b>Plain</b>	0.37	0.35	0.32	0.29
<b>Incl. 1c standard print, 1 position</b>	0.57	0.50	0.44	0.40
Each further colour	0.20	0.15	0.12	0.11
<b>Incl. digital print (CMYK), 1 motif</b>	0.72	0.65	0.59	0.55

For branding prices please refer to page 113

## BRANDING / AREA

Cap	1	Digital print	Ø 9.5 mm
Clip	2	Standard print	40 x 6 mm
		Digital print	35 x 7 mm
Barrel	3	Standard print	45 x 20 mm
		Standard print	65 x 13 mm
	5	Digital print	80 x 7 mm
		Standard print (from 1,000 pieces)	60 x 30 mm
	6	Digital print (from 1,000 pieces)	68 x 33 mm

## LIBERTY SOFT TOUCH

# MODERN DESIGN, OF PALPABLE HIGH QUALITY AS IF MADE OF SILK.

Design in its purest form: Offers the perfect setting for self-confident advertising with its purist design language and glossy colour selection. Long live your creativity.



## LIBERTY SOFT TOUCH

Image scale 1:1

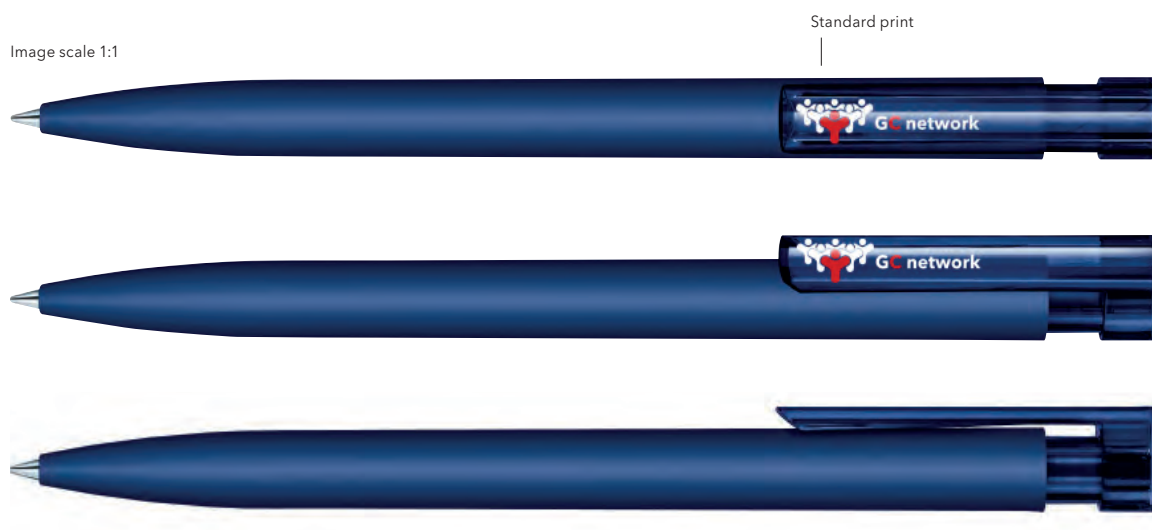

Standard print



Your desired PMS colour available from 20,000 pieces (Surcharge 1,000 €)

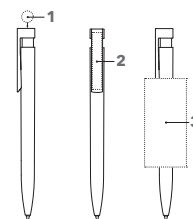

### ART. NO. 2015

#### Push ball pen

Velvety body surface, glossy transparent mid and clip surface, senator® magic flow G2 refill (1.0 mm) ink colour: blue or black

#### SERVICES

**Mix & Match:** see page 100

**PMS Service:** from 20,000 pieces, see page 101

**Express Service (Online Portal):** see page 102

### INDUSTRIAL PRICES (€/PC.)

RSP in euro, per piece, VAT not included.

2015	500	1,000	2,500	5,000
<b>Plain</b>	0.94	0.89	0.82	0.76
<b>Incl. 1c standard print, 1 position</b>	1.14	1.04	0.94	0.87
Each further colour	0.20	0.15	0.12	0.11
<b>Incl. digital print (CMYK), 1 motif</b>	1.29	1.19	1.09	1.02

For branding prices please refer to page 113

### BRANDING / AREA

Cap	1	Digital print	Ø 9.5 mm
Clip	2	Standard print	40 x 6 mm
		Digital print	35 x 7 mm
Barrel	3	Standard print	60 x 30 mm
		(from 1,000 pieces)	

# LIBERTY SOFT TOUCH MC

Image scale 1:1

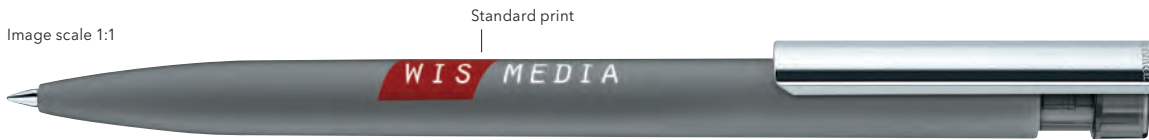

Your desired PMS colour  
available from 20,000 pieces  
(Surcharge 1,000 €)

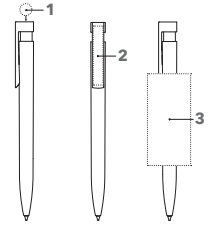

## ART. NO. 2942

### Push ball pen

Velvety body surface, glossy transparent mid and clip holder, metal clip, senator® magic flow G2 refill (1.0 mm) ink colour: blue or black

### SERVICES

**Mix & Match:** see page 100

**PMS Service:** from 20,000 pieces, see page 101

## INDUSTRIAL PRICES (€/PC.)

RSP in euro, per piece, VAT not included.

2942	500	1,000	2,500	5,000
<b>Plain</b>	1.16	1.11	1.04	0.98
<b>Incl. 1c standard print, 1 position</b>	–	1.26	1.16	1.09
Each further colour	–	0.15	0.12	0.11
<b>Incl. digital print (CMYK), 1 motif</b>	1.51	1.41	1.31	1.24
<b>Incl. Laser engraving, 1 position</b>	1.76	1.66	1.56	1.49

For branding prices please refer to page 113

## BRANDING / AREA

Cap	1	Digital print	Ø 7.5 mm
<b>Clip</b>	2	Laser engraving	45 x 6 mm
<b>Barrel</b>	3	Standard print	60 x 30 mm
		(from 1,000 pieces)	

# LIBERTY MIX & MATCH

Image scale 1:1

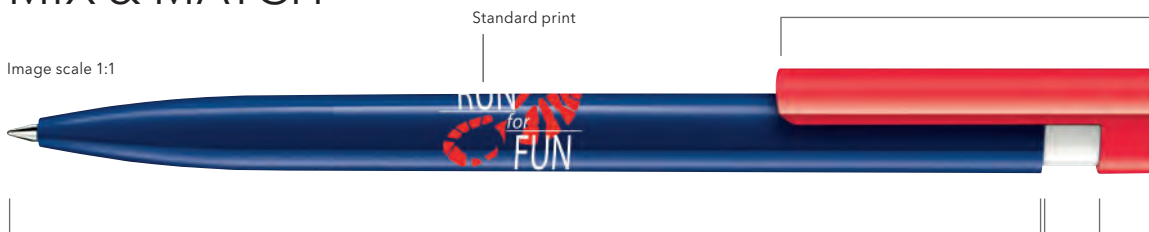

**Barrel**  
Polished  
Clear  
Soft Touch

15 standard colours  
15 standard colours  
15 standard colours

**Mid**  
Polished  
Clear

15 standard colours  
15 standard colours

**Clip**  
Polished  
Clear  
Metal  
with clear

15 standard colours  
15 standard colours  
15 standard colours

## ART. NO. 2918 / 2829

### Push ball pen

Free combination option of different parts, surfaces and colours, senator® magic flow G2 refill (1.0 mm) ink colour: blue or black

### 2918:

Barrel polished or clear and metal clip optional

### 2829:

Soft Touch barrel, metal clip optional

## INDUSTRIAL PRICES (€/PC.)

RSP in euro, per piece, VAT not included.

2918	1,000	2,500	5,000
<b>Plain</b>	0.40	0.37	0.34
<b>Incl. 1c standard print, 1 position</b>	0.55	0.49	0.45
Each further colour	0.15	0.12	0.11
<b>Incl. digital print (CMYK), 1 motif</b>	0.70	0.64	0.60
<b>Surcharge metal clip</b>	0.22	0.22	0.22
<b>Surcharge refill 1.4</b>	0.08	0.08	0.08

For branding prices please refer to page 113

2829	1,000	2,500	5,000
<b>Plain,</b>	0.92	0.85	0.80
<b>Incl. 1c standard print, 1 position</b>	1.07	0.97	0.91
Each further colour	0.15	0.12	0.11
<b>Incl. digital print (CMYK), 1 motif</b>	1.22	1.12	1.06
<b>Surcharge metal clip</b>	0.22	0.22	0.22
<b>Surcharge refill 1.4</b>	0.08	0.08	0.08

## BRANDING / AREA

Please see the Liberty models used for the branding areas on those parts or contact us

### SERVICES

**Mix & Match:** see page 100

**PMS Service:**  
from 20,000 pieces,  
see page 101

# LIBERTY CLIP4U

Image scale 1:1

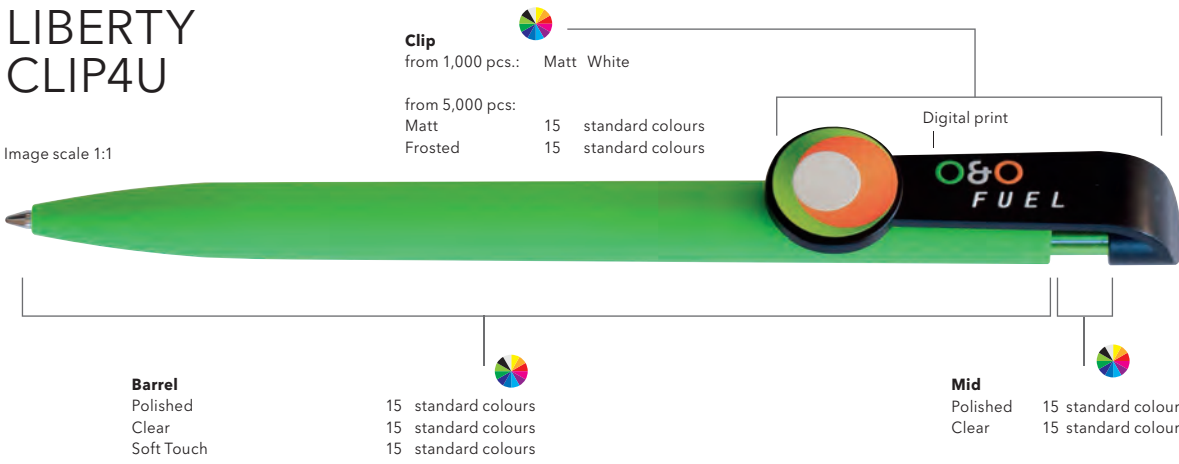

**Clip**  
from 1,000 pcs.: Matt White

from 5,000 pcs:  
Matt 15 standard colours  
Frosted 15 standard colours

**Barrel**  
Polished  
Clear  
Soft Touch

15 standard colours  
15 standard colours  
15 standard colours

**Mid**  
Polished  
Clear  
15 standard colours

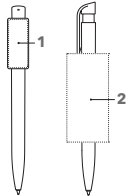

## ART. NO. 3220 / 3221

### Push ball pen

Design your own clip shape or choose your favourite from available ones. Free combination option of different parts, surfaces and accessories. senator® magic flow G2 refill (1.0 mm) ink colour: blue or black

**3220:**  
Barrel polished or clear

**3221:**  
Barrel soft touch

### SERVICES

**Mix & Match:** see page 100

**PMS Service:** from 20,000 pieces, see page 101

**Additional refill option:**  
senator® magic flow refill G2 (1.4 mm), see page 106

### BRANDING / AREA

Part	Options	Dimensions
Clip	1 Digital print	max 40,5 x 16 mm (depending on clip shape)
Barrel	2 Standard print Digital print on white barrel (from 1,000 pieces)	60 x 30 mm 70 x 33 mm

### INDUSTRIAL PRICES (€/PC.)

RSP in euro, per piece, VAT not included.

	1,000	2,500	5,000
<b>3220</b>			
<b>With standard clip shape in white, matt</b>			
Plain	0.55	0.52	0.49
incl. 1c Standard print, 1 position	0.70	0.64	0.60
Each further colour	0.15	0.12	0.11
incl. Digital print (CMYK) per motif	0.85	0.79	0.75
Surcharge magic flow refill 1.4	0.08	0.08	0.08
<b>3221</b>			
<b>With all clip shapes and colours (matt/frosted)</b>			
Plain	1.07	1.00	0.94
incl. 1c Standard print, 1 position	1.22	1.12	1.05
Each further colour	0.15	0.12	0.11
incl. Digital print (CMYK) per motif	1.37	1.27	1.20
Surcharge magic flow refill 1.4	0.08	0.08	0.08



### CLIP 4U

Design your own clip shape. Contact us for more information.



Minimum order quantity 10,000 pcs. We will be happy to submit an offer.

### STANDARD CLIP SHAPES WITHOUT TOOLING CHARGES

For these clip shapes we do not charge any tooling costs

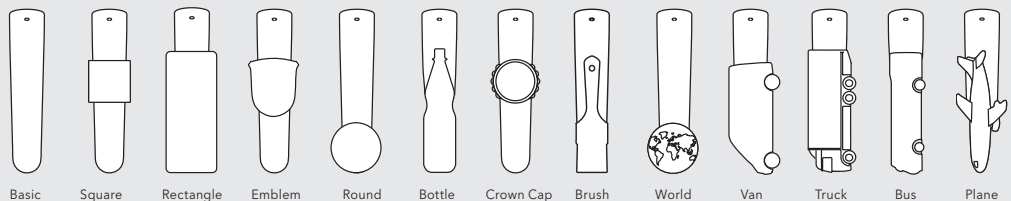

## CHALLENGER CLEAR

# THE BESTSELLER - IRRESISTIBLY CHARMING.

Design harmony in a shiny finish. The soft, restrained lines enchant everyone and form a true eye-catcher for your brand.

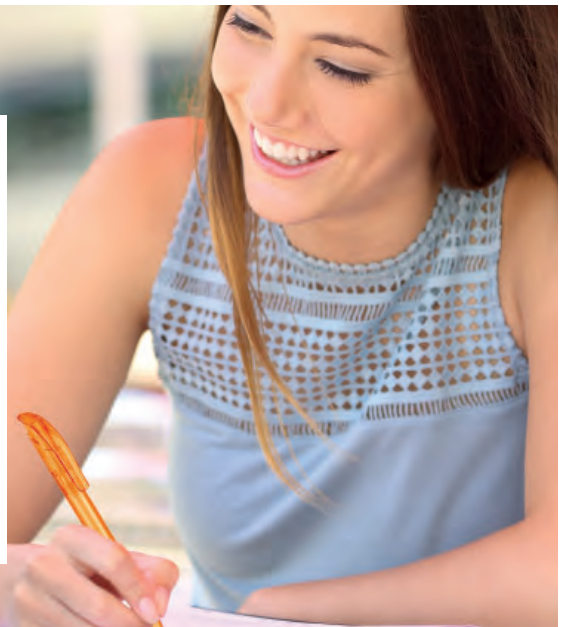

## CHALLENGER CLEAR

Image scale 1:1

Standard print



Your desired PMS colour  
available from 20,000 pieces  
(Surcharge 1,000 €)

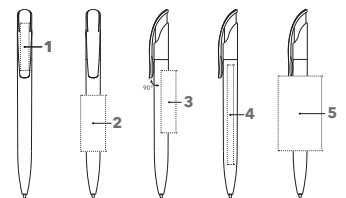

### ART. NO. 2192

#### Push ball pen

Glossy transparent body and clip surface,  
senator® magic flow G2 refill (1.0 mm)  
ink colour: blue or black

#### SERVICES

**Mix & Match:** see page 100

**PMS Service:** from 20,000 pieces, see page 101

**Express Service (Online Portal):** see page 102

**5,000 in 5:** see page 102

**NFC function:** see page 103

### INDUSTRIAL PRICES (€/PC.)

RSP in euro, per piece, VAT not included.

2192	500	1,000	2,500	5,000
Plain	0.43	0.40	0.39	0.37
Incl. 1c standard print, 1 position	0.63	0.55	0.51	0.48
Each further colour	0.20	0.15	0.12	0.11
Incl. digital print (CMYK), 1 motif	0.78	0.70	0.66	0.63

For branding prices please refer to page 113

### BRANDING / AREA

Clip	1	Standard print	35 x 7 mm or 40 x 5 mm
		Digital print	35 x 7 mm
Barrel	2	Standard print	45 x 20 mm
	3	Standard print	50 x 12 mm
	4	Digital print	80 x 7 mm
	5	Standard print (from 1,000 pieces)	60 x 35 mm

# CHALLENGER CLEAR SG

Image scale 1:1



Your desired PMS colour available from 20,000 pieces (Surcharge 1,000 €)

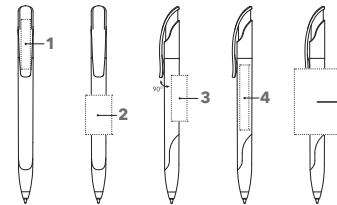

## ART. NO. 2597

### Push ball pen

Glossy transparent body and clip surface, coloured soft grip zone matching the barrel, senator® magic flow G2 refill (1.0 mm) ink colour: blue or black

### SERVICES

**Mix & Match:** see page 100

**5,000 in 5:** see page 102

**PMS Service:** from 20,000 pieces, see page 101

**NFC function:** see page 103

**Express Service (Online Portal):** see page 102

## INDUSTRIAL PRICES (€/PC.)

RSP in euro, per piece, VAT not included.

2597	500	1,000	2,500	5,000
<b>Plain</b>	0.51	0.48	0.47	0.45
<b>Incl. 1c standard print, 1 position</b>	0.71	0.63	0.59	0.56
Each further colour	0.20	0.15	0.12	0.11
<b>Incl. digital print (CMYK), 1 motif</b>	0.86	0.78	0.74	0.71

For branding prices please refer to page 113

## BRANDING / AREA

Clip	1	Standard print	35 x 7 mm or 40 x 5 mm
		Digital print	35 x 7 mm
Barrel	2	Standard print	30 x 20 mm or 45 x 10 mm
	3	Standard print	35 x 12 mm
	4	Digital print	60 x 7 mm
	5	Standard print (from 1,000 pieces)	50 x 35 mm

# CHALLENGER CLEAR MT

Image scale 1:1



Your desired PMS colour available from 20,000 pieces (Surcharge 1,000 €)

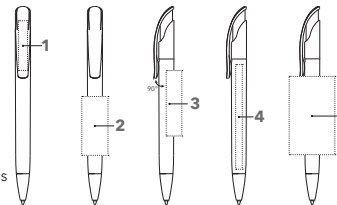

## ART. NO. 2925

### Push ball pen

Glossy transparent body and clip surface, glossy metal tip, senator® magic flow G2 refill (1.0 mm) ink colour: blue or black

### SERVICES

**Mix & Match:** see page 100

**PMS Service:** from 20,000 pieces, see page 101

**NFC function:** see page 103

**Express Service (Online Portal):** see page 102

## INDUSTRIAL PRICES (€/PC.)

RSP in euro, per piece, VAT not included.

2925	500	1,000	2,500	5,000
<b>Plain</b>	0.78	0.75	0.74	0.72
<b>Incl. 1c standard print, 1 position</b>	0.98	0.90	0.86	0.83
Each further colour	0.20	0.15	0.12	0.11
<b>Incl. digital print (CMYK), 1 motif</b>	1.13	1.05	1.01	0.98

For branding prices please refer to page 113

## BRANDING / AREA

Clip	1	Standard print	35 x 7 mm or 40 x 5 mm
		Digital print	35 x 7 mm
Barrel	2	Standard print	45 x 20 mm
	3	Standard print	50 x 12 mm
	4	Digital print	80 x 7 mm
	5	Standard print (from 1,000 pieces)	60 x 35 mm

# CHALLENGER FROSTED

Image scale 1:1



Your desired PMS colour available from 20,000 pieces (Surcharge 1,000 €)

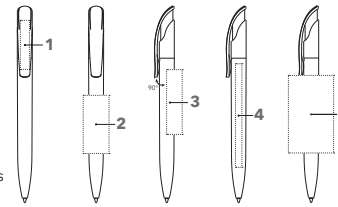

## ART. NO. 2418

### Push ball pen

Translucent shine-free body and clip surface, senator® magic flow G2 refill (1.0 mm) ink colour: blue or black

### SERVICES

**Mix & Match:** see page 100

**PMS Service:** from 20,000 pieces, see page 101

**Express Service (Online Portal):** see page 102

**5.000 in 5:** see page 102

**NFC function:** see page 103

## INDUSTRIAL PRICES (€/PC.)

RSP in euro, per piece, VAT not included.

2418	500	1,000	2,500	5,000
<b>Plain</b>	0.47	0.44	0.42	0.40
<b>Incl. 1c standard print, 1 position</b>	0.67	0.59	0.54	0.51
Each further colour	0.20	0.15	0.12	0.11
<b>Incl. digital print (CMYK), 1 motif</b>	0.82	0.74	0.69	0.66

For branding prices please refer to page 113

## BRANDING / AREA

Clip	1	Standard print	35 x 7 mm or 40 x 5 mm
		Digital print	35 x 7 mm
Barrel	2	Standard print	45 x 20 mm
	3	Standard print	50 x 12 mm
	4	Digital print	80 x 7 mm
	5	Standard print (from 1,000 pieces)	60 x 35 mm

# CHALLENGER POLISHED

Image scale 1:1

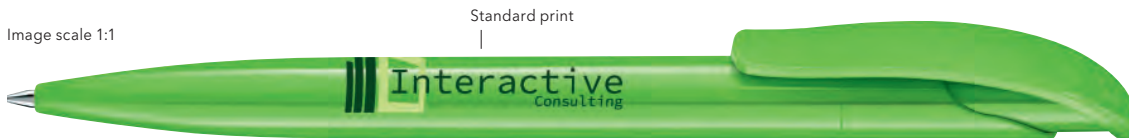

Your desired PMS colour available from 20,000 pieces (Surcharge 1,000 €)

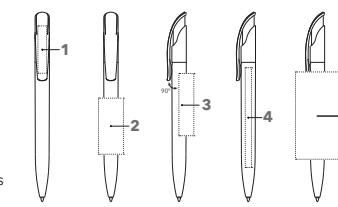

## ART. NO. 2416

### Push ball pen

Glossy opaque body and clip surface, senator® magic flow G2 refill (1.0 mm) ink colour: blue or black

### SERVICES

**Mix & Match:** see page 100

**PMS Service:** from 20,000 pieces, see page 101

**Express Service (Online Portal):** see page 102

**5.000 in 5:** see page 102

**NFC function:** see page 103

## INDUSTRIAL PRICES (€/PC.)

RSP in euro, per piece, VAT not included.

2416	500	1,000	2,500	5,000
<b>Plain</b>	0.41	0.38	0.37	0.35
<b>Incl. 1c standard print, 1 position</b>	0.61	0.53	0.49	0.46
Each further colour	0.20	0.15	0.12	0.11
<b>Incl. digital print (CMYK), 1 motif</b>	0.76	0.68	0.64	0.61

For branding prices please refer to page 113

## BRANDING / AREA

Clip	1	Standard print	35 x 7 mm or 40 x 5 mm
		Digital print	35 x 7 mm
Barrel	2	Standard print	45 x 20 mm
	3 <td>Standard print</td> <td>50 x 12 mm</td>	Standard print	50 x 12 mm
	4 <td>Digital print</td> <td>80 x 7 mm</td>	Digital print	80 x 7 mm
	5 <td>Digital print on white barrel (from 1,000 pieces)</td> <td>70 x 35 mm</td>	Digital print on white barrel (from 1,000 pieces)	70 x 35 mm
		Standard print (from 1,000 pieces)	60 x 35 mm

## CHALLENGER POLISHED BASIC

### THE BESTSELLER – IMPRESSIVELY CONSISTENT.

Design harmony in a classic white finish with colour accents. The soft, discreet lines charm everyone and form a true eye-catcher for your brand.

## CHALLENGER POLISHED BASIC

Image scale 1:1

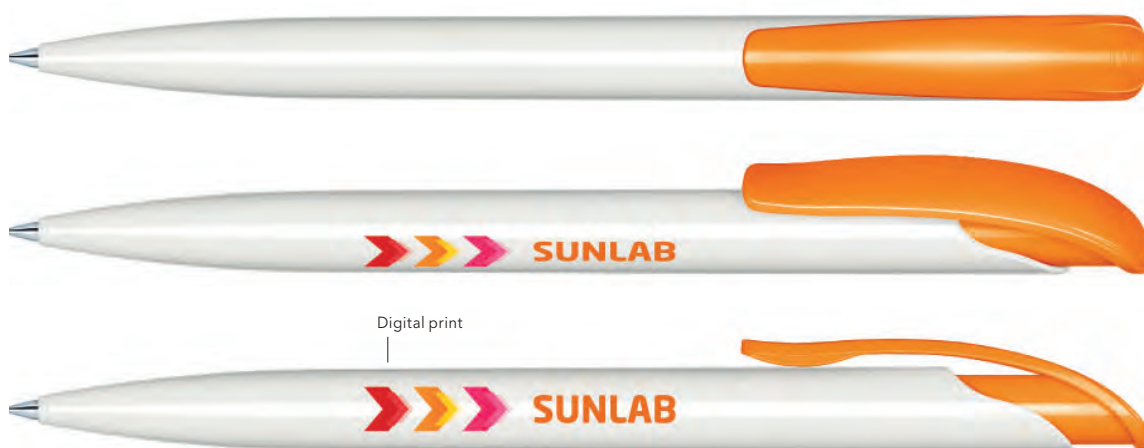

Your desired PMS colour available from 20,000 pieces (Surcharge 1,000 €)

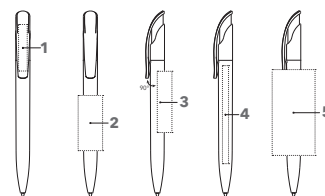

#### ART. NO. 2957

##### Push ball pen

Glossy opaque body and clip surface, white barrel, coloured clip, senator® magic flow G2 refill (1.0 mm) ink colour: blue or black

##### SERVICES

**Mix & Match:** see page 100

**PMS Service:** from 20,000 pieces, see page 101

**5.000 in 5:** see page 102

**Express Service (Online Portal):** see page 102

**NFC function:** see page 103

#### INDUSTRIAL PRICES (€/PC.)

RSP in euro, per piece, VAT not included.

2957	500	1,000	2,500	5,000
<b>Plain</b>	0,41	0,38	0,37	0,35
<b>Incl. 1c standard print, 1 position</b>	0,61	0,53	0,49	0,46
Each further colour	0,20	0,15	0,12	0,11
<b>Incl. digital print (CMYK), 1 motif</b>	0,76	0,68	0,64	0,61

For branding prices please refer to page 113

#### BRANDING / AREA

Clip	1	Standard print	35 x 7 mm or 40 x 5 mm
		Digital print	35 x 7 mm
Barrel	2	Standard print	45 x 20 mm
	3	Standard print	50 x 12 mm
	4	Digital print	80 x 7 mm
	5	Standard print (from 1,000 pieces)	60 x 35 mm
		Digital print (from 1,000 pieces)	70 x 35 mm



# CHALLENGER POLISHED BASIC SG

Image scale 1:1

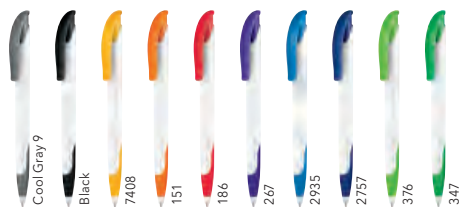

Your desired PMS colour available from 20,000 pieces (Surcharge 1,000 €)

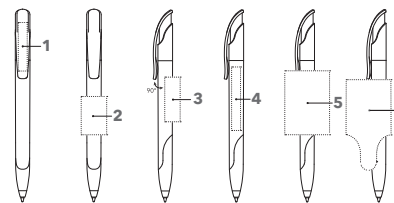

## ART. NO. 2958

### Push ball pen

Glossy opaque body and clip surface, white barrel, coloured clip and soft grip zone, senator® magic flow G2 refill (1.0 mm) ink colour: blue or black

### SERVICES

**Mix & Match:** see page 100

**PMS Service:** from 20,000 pieces, see page 101

**NFC function:** see page 103

## INDUSTRIAL PRICES (€/PC.)

RSP in euro, per piece, VAT not included.

2958	500	1,000	2,500	5,000
<b>Plain</b>	0.49	0.46	0.45	0.43
<b>Incl. 1c standard print, 1 position</b>	0.69	0.61	0.57	0.54
Each further colour	0.20	0.15	0.12	0.11
<b>Incl. digital print (CMYK), 1 motif</b>	0.84	0.76	0.72	0.69

For branding prices please refer to page 113

## BRANDING / AREA

Clip	1	Standard print	35 x 7 mm or 40 x 5 mm
		Digital print	35 x 7 mm
Barrel	2	Standard print	30 x 20 mm or 45 x 10 mm
	3	Standard print	35 x 12 mm
	4	Digital print	60 x 7 mm
	5	Digital print (from 1,000 pieces)	60 x 35 mm
	6	Standard print (from 1,000 pieces)	50 x 35 mm

# CHALLENGER POLISHED MT

Image scale 1:1



Your desired PMS colour available from 20,000 pieces (Surcharge 1,000 €)

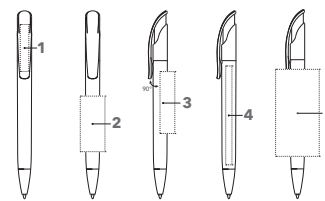

## ART. NO. 2926

### Push ball pen

Glossy opaque body and clip surface, glossy metal tip, senator® magic flow G2 refill (1.0 mm) ink colour: blue or black

### SERVICES

**Mix & Match:** see page 100

**PMS Service:** from 20,000 pieces, see page 101

**NFC function:** see page 103

## INDUSTRIAL PRICES (€/PC.)

RSP in euro, per piece, VAT not included.

2926	500	1,000	2,500	5,000
<b>Plain</b>	0.76	0.73	0.72	0.70
<b>Incl. 1c standard print, 1 position</b>	0.96	0.88	0.84	0.81
Each further colour	0.20	0.15	0.12	0.11
<b>Incl. digital print (CMYK), 1 motif</b>	1.11	1.03	0.99	0.96

For branding prices please refer to page 113

## BRANDING / AREA

Clip	1	Standard print	35 x 7 mm or 40 x 5 mm
		Digital print	35 x 7 mm
Barrel	2	Standard print	45 x 20 mm
	3	Standard print	50 x 12 mm
	4	Digital print	80 x 7 mm
	5	Digital print on white barrel (from 1,000 pieces)	70 x 35 mm
		Standard print (from 1,000 pieces)	60 x 35 mm

# CHALLENGER SOFT TOUCH

Image scale 1:1



Your desired PMS colour  
available from 20,000 pieces  
(Surcharge 1,000 €)

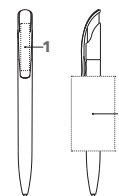

## ART. NO. 2737

### Push ball pen

Velvety body surface, transparent clip,  
senator® magic flow G2 refill (1.0 mm)  
ink colour: blue or black

### SERVICES

**PMS Service:** from 20,000 pieces, see page 101

**NFC function:** see page 103

## INDUSTRIAL PRICES (€/PC.)

RSP in euro, per piece, VAT not included.

2737	500	1,000	2,500	5,000
<b>Plain</b>	0.98	0.95	0.94	0.92
<b>Incl. 1c standard print, 1 position</b>	1.18	1.10	1.06	1.03
Each further colour	0.20	0.15	0.12	0.11
<b>Incl. digital print (CMYK), 1 motif</b>	1.33	1.25	1.21	1.18

For branding prices please refer to page 113

## BRANDING / AREA

Clip	1	Standard print	35 x 7 mm or 40 x 5 mm
		Digital print	35 x 7 mm
Barrel	2	Standard print (from 1,000 pieces)	60 x 35 mm

# CHALLENGER MIX & MATCH

Image scale 1:1



### Barrel

Polished	15	standard colours
Polished white with soft grip	10	Basic colours
Polished with metal tip	2	Black, White
Clear	15	standard colours
Clear with soft grip	14	standard colours
Clear with metal tip	15	standard colours
Frosted	15	standard colours

### Upper

Polished	15	standard colours
Clear	15	standard colours
Frosted	15	standard colours

### Clip

Polished	15	standard colours
Clear	15	standard colours
Frosted	15	standard colours

## ART. NO. 2927

### Push ball pen

Free combination option of different parts  
(barrel, upper, clip). surfaces (clear, polished,  
frosted). accessories and colours,  
senator® magic flow G2 refill (1.0 mm)  
ink colour: blue or black

### SERVICES

**Mix & Match:** see page 100

**PMS Service:** from 20,000 pieces, see page 101

**NFC function:** see page 103

## INDUSTRIAL PRICES (€/PC.)

RSP in euro, per piece, VAT not included.

2927	1,000	2,500	5,000
<b>Plain</b>	0.43	0.42	0.40
<b>Incl. 1c standard print, 1 position</b>	0.58	0.54	0.51
Each further colour	0.15	0.12	0.11
<b>Incl. digital print (CMYK), 1 motif</b>	0.73	0.69	0.66
<b>Surcharge soft grip</b>	0.08	0.08	0.08
<b>Surcharge metal tip</b>	0.35	0.35	0.35
<b>Surcharge refill 1.4</b>	0.08	0.08	0.08

For branding prices please refer to page 113

## BRANDING / AREA

Please see the Challenger models  
used for the branding areas on  
those parts or contact us.

### Additional refill option:

senator® magic flow refill G2 (1.4 mm)  
see page 106

# SUPER HIT CLEAR

Image scale 1:1



Your desired PMS colour available from 20,000 pieces (Surcharge 1,000 €)

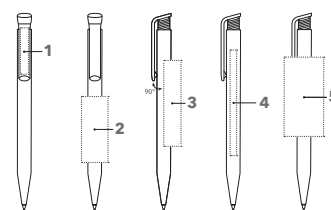

## ART. NO. 2756

### Push ball pen

Glossy transparent body surface and shiny opaque clip, senator® magic flow X20 refill (1.0 mm), ink colour: blue or black

### SERVICES

Mix & Match: see page 100

PMS Service: from 20,000 pieces, see page 101

5.000 in 5: see page 102

## INDUSTRIAL PRICES (€/PC.)

RSP in euro, per piece, VAT not included.

2756	500	1,000	2,500	5,000
<b>Plain</b>	0.28	0.26	0.24	0.23
<b>Incl. 1c standard print, 1 position</b>	0.48	0.41	0.36	0.34
Each further colour	0.20	0.15	0.12	0.11
<b>Incl. digital print (CMYK), 1 motif</b>	0.63	0.56	0.51	0.49

For branding prices please refer to page 113

## BRANDING / AREA

Clip	1	Standard print	35 x 6 mm
		Digital print	35 x 7 mm
Barrel	2	Standard print	50 x 20 mm
	3	Standard print	65 x 13 mm
	4	Digital print	80 x 7 mm
	5	Standard print (from 1,000 pieces)	60 x 30 mm

# SUPER HIT CLEAR SG

Image scale 1:1



Your desired PMS colour available from 20,000 pieces (Surcharge 1,000 €)

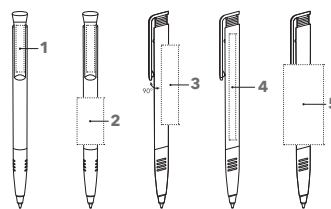

## ART. NO. 2234

### Push ball pen

Glossy transparent body surface and shiny opaque clip, coloured soft grip zone, senator® magic flow X20 refill (1.0 mm), ink colour: blue or black

### SERVICES

Mix & Match: see page 100

PMS Service: from 20,000 pieces, see page 101

Express Service (Online Portal): see page 102

5.000 in 5: see page 102

## INDUSTRIAL PRICES (€/PC.)

RSP in euro, per piece, VAT not included.

2234	500	1,000	2,500	5,000
<b>Plain</b>	0.36	0.34	0.32	0.31
<b>Incl. 1c standard print, 1 position</b>	0.56	0.49	0.44	0.42
Each further colour	0.20	0.15	0.12	0.11
<b>Incl. digital print (CMYK), 1 motif</b>	0.71	0.64	0.59	0.57

For branding prices please refer to page 113

## BRANDING / AREA

Clip	1	Standard print	35 x 6 mm
		Digital print	35 x 7 mm
Barrel	2	Standard print	35 x 20 mm
	3	Standard print	60 x 12 mm
	4	Digital print	80 x 7 mm
	5	Standard print (from 1,000 pieces)	60 x 30 mm

# SUPER HIT FROSTED

Image scale 1:1



Your desired PMS colour available from 20,000 pieces (Surcharge 1,000 €)

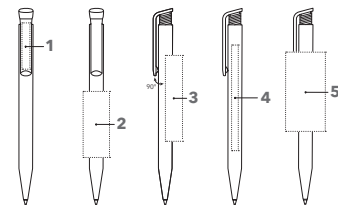

## ART. NO. 2244

### Push ball pen

Translucent shine-free body surface, glossy opaque clip, senator® magic flow X20 refill (1.0 mm) ink colour: blue or black

### SERVICES

**Mix & Match:** see page 100

**PMS Service:** from 20,000 pieces, see page 101

**Express Service (Online Portal):** see page 102

**5.000 in 5:** see page 102

## INDUSTRIAL PRICES (€/PC.)

RSP in euro, per piece, VAT not included.

2244	500	1,000	2,500	5,000
<b>Plain</b>	0.29	0.26	0.24	0.23
<b>Incl. 1c standard print, 1 position</b>	0.49	0.41	0.36	0.34
Each further colour	0.20	0.15	0.12	0.11
<b>Incl. digital print (CMYK), 1 motif</b>	0.64	0.56	0.51	0.49

For branding prices please refer to page 113

## BRANDING / AREA

Clip	1	Standard print	35 x 6 mm
		Digital print	35 x 7 mm
Barrel	2	Standard print	50 x 20 mm
	3	Standard print	65 x 13 mm
	4	Digital print	80 x 7 mm
	5	Standard print (from 1,000 pieces)	60 x 30 mm

# SUPER HIT MATT

Image scale 1:1

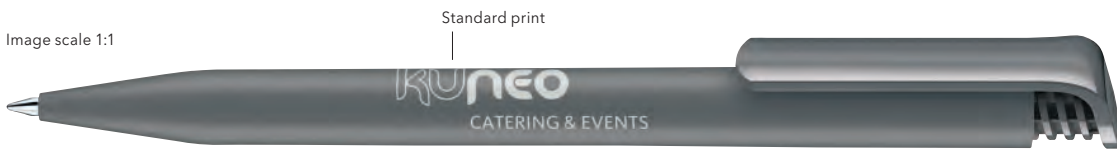

Your desired PMS colour available from 20,000 pieces (Surcharge 1,000 €)

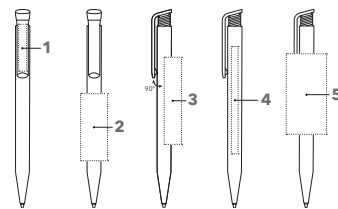

## ART. NO. 2904

### Push ball pen

Opaque, shine-free finish body surface, glossy opaque clip, senator® magic flow X20 refill (1.0 mm), ink colour: blue or black

### SERVICES

**Mix & Match:** see page 100

**PMS Service:** from 20,000 pieces, see page 101

**5.000 in 5:** see page 102

## INDUSTRIAL PRICES (€/PC.)

RSP in euro, per piece, VAT not included.

2904	500	1,000	2,500	5,000
<b>Plain</b>	0.27	0.24	0.22	0.21
<b>Incl. 1c standard print, 1 position</b>	0.47	0.39	0.34	0.32
Each further colour	0.20	0.15	0.12	0.11
<b>Incl. digital print (CMYK), 1 motif</b>	0.62	0.54	0.49	0.47

For branding prices please refer to page 113

## BRANDING / AREA

Clip	1	Standard print	35 x 6 mm
		Digital print	35 x 7 mm
Barrel	2	Standard print	50 x 20 mm
	3	Standard print	65 x 13 mm
	4	Digital print	80 x 7 mm
	5	Standard print (from 1,000 pieces)	60 x 30 mm

# SUPER HIT POLISHED

Image scale 1:1



Your desired PMS colour  
available from 20,000 pieces  
(Surcharge 1,000 €)

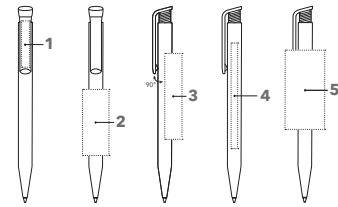

## ART. NO. 2883

### Push ball pen

Glossy opaque body and clip surface,  
senator® magic flow X20 refill (1.0 mm)  
ink colour: blue or black

### SERVICES

**Mix & Match:** see page 100

**PMS Service:** from 20,000 pieces, see page 101

**Express Service (Online Portal):** see page 102

**5.000 in 5:** see page 102

## INDUSTRIAL PRICES (€/PC.)

RSP in euro, per piece, VAT not included.

2883	500	1,000	2,500	5,000
<b>Plain</b>	0.26	0.24	0.22	0.21
<b>Incl. 1c standard print, 1 position</b>	0.46	0.39	0.34	0.32
Each further colour	0.20	0.15	0.12	0.11
<b>Incl. digital print (CMYK), 1 motif</b>	0.61	0.54	0.49	0.47

For branding prices please refer to page 113

## BRANDING / AREA

Clip	1	Standard print	35 x 6 mm
		Digital print	35 x 7 mm
Barrel	2	Standard print	50 x 20 mm
	3	Standard print	65 x 13 mm
	4	Digital print	80 x 7 mm
	5	Standard print (from 1,000 pieces)	60 x 30 mm
		Digital print on white barrel (from 1,000 pieces)	70 x 33 mm

# SUPER HIT POLISHED BASIC

Image scale 1:1



Your desired PMS colour  
available from 20,000 pieces  
(Surcharge 1,000 €)

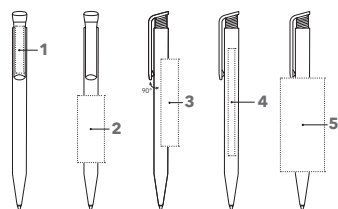

## ART. NO. 2955

### Push ball pen

Polished opaque body and clip surface, white  
barrel, coloured clip,  
senator® magic flow X20 refill (1.0 mm),  
ink colour: blue or black

### SERVICES

**Mix & Match:** see page 100

**PMS Service:** from 20,000 pieces, see page 101

**Express Service (Online Portal):** see page 102

**5.000 in 5:** see page 102

## INDUSTRIAL PRICES (€/PC.)

RSP in euro, per piece, VAT not included.

2955	500	1,000	2,500	5,000
<b>Plain</b>	0.26	0.24	0.22	0.21
<b>Incl. 1c standard print, 1 position</b>	0.46	0.39	0.34	0.32
Each further colour	0.20	0.15	0.12	0.11
<b>Incl. digital print (CMYK), 1 motif</b>	0.61	0.54	0.49	0.47

For branding prices please refer to page 113

## BRANDING / AREA

Clip	1	Standard print	35 x 6 mm
		Digital print	35 x 7 mm
Barrel	2	Standard print	50 x 20 mm
	3	Standard print	65 x 13 mm
	4	Digital print	80 x 7 mm
	5	Standard print (from 1,000 pieces)	60 x 30 mm
		Digital print (from 1,000 pieces)	70 x 33 mm

# SUPER HIT POLISHED BASIC SG

Image scale 1:1



Your desired PMS colour available from 20,000 pieces (Surcharge 1,000 €)

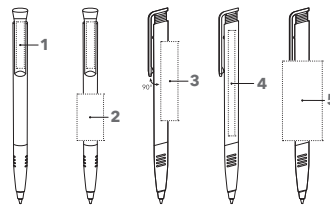

## ART. NO. 2956

### Push ball pen

Polished opaque body and clip surface, white barrel, coloured clip and soft grip zone, senator® magic flow X20 refill (1.0 mm), ink colour: blue or black

### SERVICES

**Mix & Match:** see page 100

**PMS Service:** from 20,000 pieces, see page 101

## INDUSTRIAL PRICES (€/PC.)

RSP in euro, per piece, VAT not included.

2956	500	1,000	2,500	5,000
<b>Plain</b>	0.34	0.32	0.30	0.29
<b>Incl. 1c standard print, 1 position</b>	0.54	0.47	0.42	0.40
Each further colour	0.20	0.15	0.12	0.11
<b>Incl. digital print (CMYK), 1 motif</b>	0.69	0.62	0.57	0.55

For branding prices please refer to page 113

## BRANDING / AREA

Clip	1	Standard print	35 x 6 mm
		Digital print	35 x 7 mm
Barrel	2	Standard print	35 x 20 mm
	3	Standard print	60 x 12 mm
	4	Digital print	80 x 7 mm
	5	Standard print (from 1,000 pieces)	60 x 30 mm

# SUPER HIT MIX & MATCH

Image scale 1:1

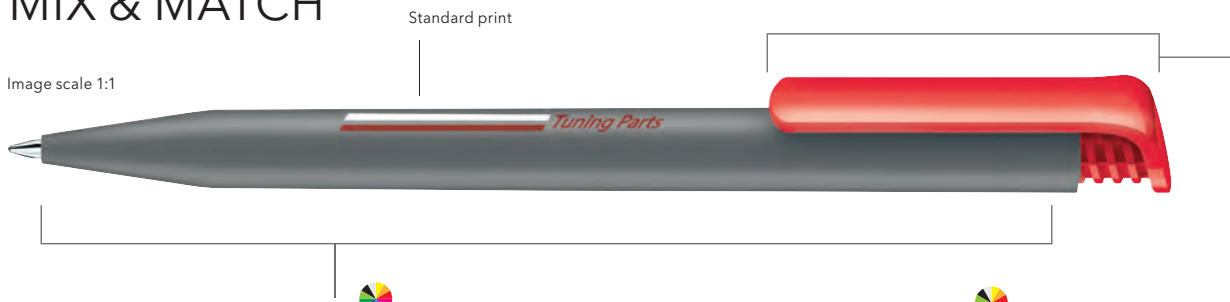

### Barrel

- Polished 15 standard colours
- Polished white with soft grip 10 Basic colours
- Matt 15 standard colours
- Clear 15 standard colours
- Clear with soft grip 14 standard colours
- Frosted 15 standard colours



### Clip

- Polished 15 standard colours



## ART. NO. 2773

### Push ball pen

Free combination option of different parts (barrel and clip), surfaces (clear, polished, frosted, matt) and colours, senator® magic flow X20 refill (1.0 mm), ink colour: blue or black

### SERVICES

**Mix & Match:** see page 100

**PMS Service:** from 20,000 pieces, see page 101

## INDUSTRIAL PRICES (€/PC.)

RSP in euro, per piece, VAT not included.

2773	1,000	2,500	5,000
<b>Plain</b>	0.29	0.27	0.26
<b>Incl. 1c standard print, 1 position</b>	0.44	0.39	0.37
Each further colour	0.15	0.12	0.11
<b>Incl. digital print (CMYK), 1 motif</b>	0.59	0.54	0.52
<b>Surcharge soft grip</b>	0.08	0.08	0.08

For branding prices please refer to page 113

## BRANDING / AREA

Please see the Super Hit models used for the branding areas on those parts or contact us.

# DART CLEAR

Image scale 1:1

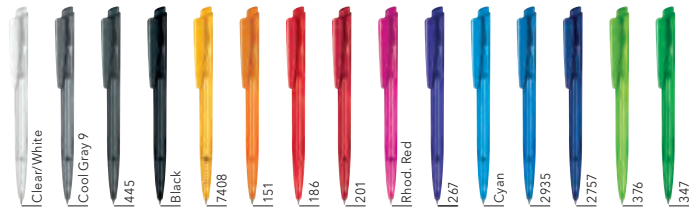

Your desired PMS colour available from 20,000 pieces (Surcharge 1,000 €)

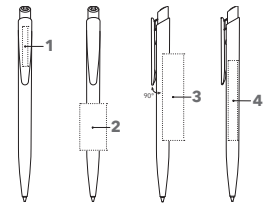

## ART. NO. 2602

### Push ball pen

Glossy transparent body surface, glossy opaque clip, senator® magic flow X20 refill (1.0 mm), ink colour: blue or black

### SERVICES

**PMS Service:** from 20,000 pieces, see page 101  
**5.000 in 5:** see page 102

## INDUSTRIAL PRICES (€/PC.)

RSP in euro, per piece, VAT not included.

2602	500	1,000	2,500	5,000
<b>Plain</b>	0.24	0.22	0.20	0.18
<b>Incl. 1c standard print, 1 position</b>	0.44	0.37	0.32	0.29
Each further colour	0.20	0.15	0.12	0.11
<b>Incl. digital print (CMYK), 1 motif</b>	0.59	0.52	0.47	0.44

For branding prices please refer to page 113

## BRANDING / AREA

Clip	1	Standard print	30 x 4 mm or 25 x 5 mm or 20 x 6 mm
		Digital print	33 x 4 mm or 28 x 5 mm or 23 x 6 mm
Barrel	2	Standard print	35 x 20 mm
	3	Standard print	65 x 12 mm
	4	Digital print	60 x 7 mm

# DART POLISHED

Image scale 1:1



Your desired PMS colour available from 20,000 pieces (Surcharge 1,000 €)

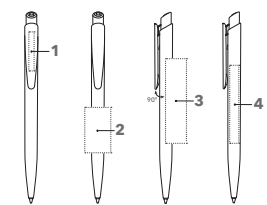

## ART. NO. 2600

### Push ball pen

Glossy opaque body and clip surface, senator® magic flow X20 refill (1.0 mm), ink colour: blue or black

### SERVICES

**PMS Service:** from 20,000 pieces, see page 101  
**5.000 in 5:** see page 102

## INDUSTRIAL PRICES (€/PC.)

RSP in euro, per piece, VAT not included.

2600	500	1,000	2,500	5,000
<b>Plain</b>	0.22	0.20	0.18	0.16
<b>Incl. 1c standard print, 1 position</b>	0.42	0.35	0.30	0.27
Each further colour	0.20	0.15	0.12	0.11
<b>Incl. digital print (CMYK), 1 motif</b>	0.57	0.50	0.45	0.42

For branding prices please refer to page 113

## BRANDING / AREA

Clip	1	Standard print	30 x 4 mm or 25 x 5 mm or 20 x 6 mm
		Digital print	33 x 4 mm or 28 x 5 mm or 23 x 6 mm
Barrel	2	Standard print	35 x 20 mm
	3	Standard print	65 x 12 mm
	4	Digital print	60 x 7 mm

# DART POLISHED BASIC

Image scale 1:1

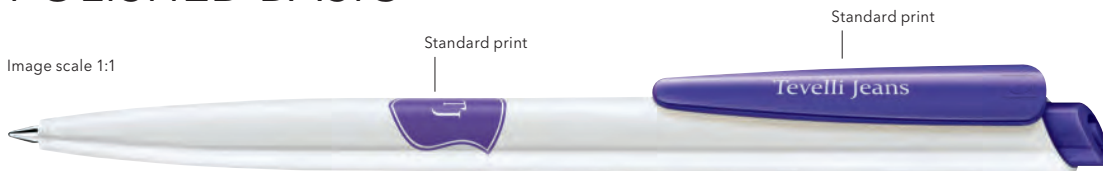

Your desired PMS colour available from 20,000 pieces (Surcharge 1,000 €)

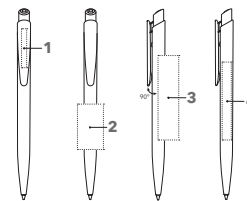

## ART. NO. 2959

### Push ball pen

Glossy opaque body and clip surface, white barrel, coloured clip, senator® magic flow X20 refill (1.0 mm), ink colour: blue or black

### SERVICES

**PMS Service:** from 20,000 pieces, see page 101  
**5.000 in 5:** see page 102

## INDUSTRIAL PRICES (€/PC.)

RSP in euro, per piece, VAT not included.

2959	500	1,000	2,500	5,000
<b>Plain</b>	0.22	0.20	0.18	0.16
<b>Incl. 1c standard print, 1 position</b>	0.42	0.35	0.30	0.27
Each further colour	0.20	0.15	0.12	0.11
<b>Incl. digital print (CMYK), 1 motif</b>	0.57	0.50	0.45	0.42

For branding prices please refer to page 113

## BRANDING / AREA

Clip	1 Standard print	30 x 4 mm or 25 x 5 mm or 20 x 6 mm
	Digital print	33 x 4 mm or 28 x 5 mm or 23 x 6 mm
Barrel	<b>2</b> Standard print	35 x 20 mm
	<b>3</b> Standard print	65 x 12 mm
	<b>4</b> Digital print	60 x 7 mm

# BIG PEN POLISHED BASIC

Image scale 1:1



Your desired PMS colour available from 30,000 pieces (Surcharge 1,000 €)

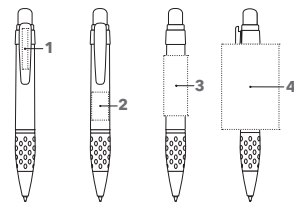

## ART. NO. 2994

### Push ball pen

White barrel with glossy opaque body surface, coloured soft grip zone, clip and push button, X20 jumbo refill, ink colour: blue or black

### SERVICES

**Mix & Match:** see page 100  
**PMS Service:** from 30,000 pieces, see page 101

## INDUSTRIAL PRICES (€/PC.)

RSP in euro, per piece, VAT not included.

2994	500	1,000	2,500	5,000
<b>Plain</b>	0.60	0.57	0.52	0.49
<b>Incl. 1c standard print, 1 position</b>	0.80	0.72	0.64	0.60
Each further colour	0.20	0.15	0.12	0.11
<b>Incl. digital print (CMYK), 1 motif</b>	0.95	0.87	0.79	0.75

For branding prices please refer to page 113

## BRANDING / AREA

Clip	1 Standard print	29 x 4 mm
Barrel	<b>2</b> Standard print (from 1,000 pieces)	20 x 12 mm
	<b>3</b> Standard print	43 x 17 mm
	<b>4</b> Standard print (from 1,000 pieces)	61 x 40.9 mm
	Digital print (from 1,000 pieces)	61.6 x 41 mm



# BIG PEN MIX & MATCH

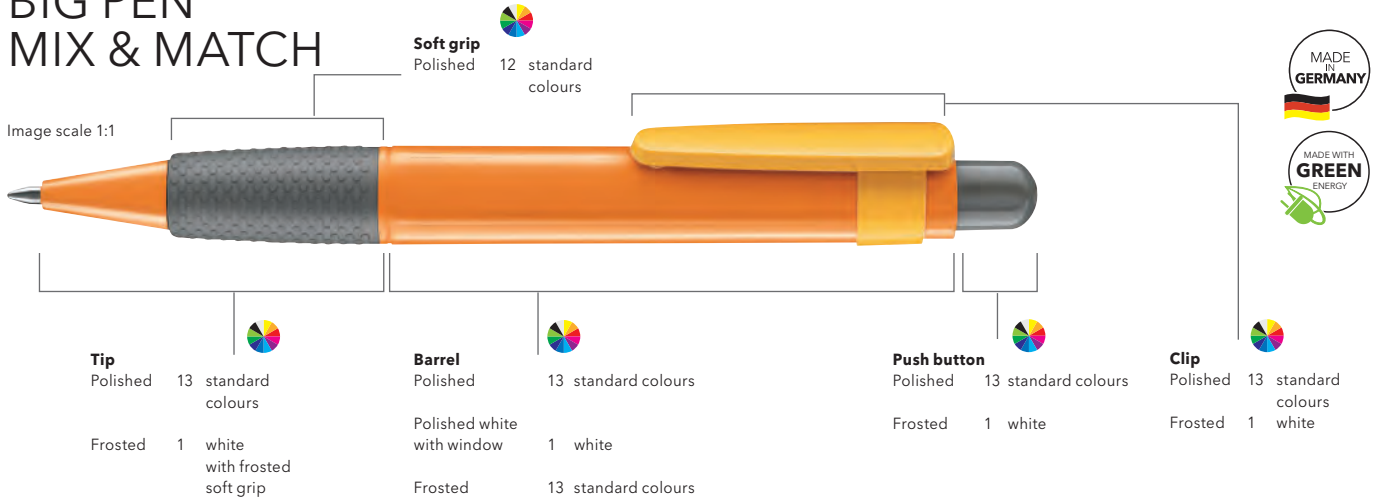

## COLOURS POLISHED



## COLOURS FROSTED



Your desired PMS colour available from 30,000 pieces (Surcharge 1,000 €)

## INDUSTRIAL PRICES (€/PC.)

RSP in euro, per piece, VAT not included.

2774	1,000	2,500	5,000
<b>Plain</b>	0.64	0.59	0.56
<b>Incl. 1c standard print, 1 position</b>	0.79	0.71	0.67
Each further colour	0.15	0.12	0.11
<b>Incl. digital print (CMYK), 1 motif</b>	0.94	0.86	0.82
<b>Surcharge barrel with text tube</b>	0.08	0.08	0.08

For branding prices please refer to page 113

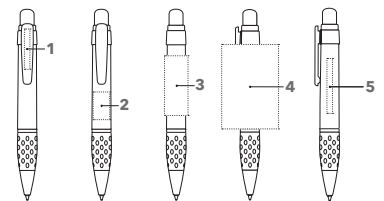

## ART. NO. 2774

### Push ball pen

Free combination option of different parts, surfaces and colours, X20 jumbo refill, ink colour: blue or black

### Note:

The white polished barrel is optionally available with viewing window for rotating text underneath.

## SERVICES

**Mix & Match:** see page 100

**PMS Service:** from 30,000 pieces, see page 101

## BRANDING / AREA

Clip	1	Standard print	29 x 4 mm
Barrel	2	Standard print	20 x 12 mm
	3	Standard print	43 x 17 mm
	4	Digital print on polished white barrel (not on barrel with window) (from 1,000 pieces)	61.6 x 41 mm
		Standard print (from 1,000 pieces)	61 x 40.9 mm
	5	Standard print on text tube	6 lines 38 x 3 mm 1 colour

# POINT POLISHED

Image scale 1:1

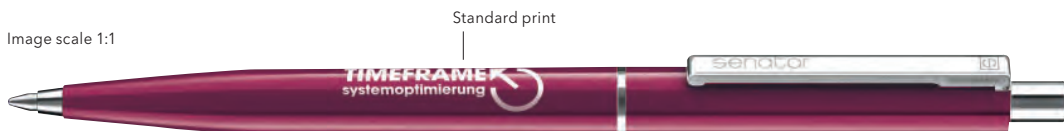

Your desired PMS colour available from 20,000 pieces (Surcharge 1,000 €)

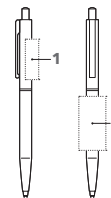

## ART. NO. 3217

### Push ball pen

Glossy opaque body surface, metal fittings, push-button with plastic inlay, senator® magic flow X20 refill (1.0 mm), ink colour: blue or black

### SERVICES

**PMS Service:** from 20,000 pieces, see page 101

## INDUSTRIAL PRICES (€/PC.)

RSP in euro, per piece, VAT not included.

3217	500	1,000	2,500	5,000
<b>Plain</b>	0.36	0.33	0.30	0.28
<b>Incl. 1c standard print, 1 position</b>	0.56	0.48	0.42	0.39
Each further colour	0.20	0.15	0.12	0.11

For branding prices please refer to page 113

## BRANDING / AREA

Upper	1	Standard print	30 x 10 mm
Barrel	2	Standard print	40 x 20 mm

# POINT METAL

Image scale 1:1



Your desired PMS colour available from 30,000 pieces (Surcharge 1,000 €)

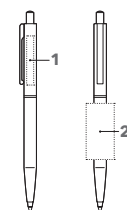

## ART. NO. 2866

### Push ball pen

Polished opaque body surface, metal upper part, metal fittings, push-button with plastic inlay, senator® metal refill G2 (1.0 mm), ink colour: blue

### SERVICES

**PMS Service:** from 30,000 pieces, see page 101

## INDUSTRIAL PRICES (€/PC.)

RSP in euro, per piece, VAT not included.

2866	500	1,000	2,500	5,000
<b>Plain</b>	0.92	0.90	0.89	0.84
<b>Incl. 1c standard print, 1 position</b>	1.12	1.05	1.01	0.95
Each further colour	0.20	0.15	0.12	0.11
<b>Incl. Laser engraving, 1 position</b>	1.52	1.45	1.41	1.35

For branding prices please refer to page 113

## BRANDING / AREA

Upper	1	Laser engraving	35 x 5 mm
Barrel	2	Standard print	40 x 20 mm

# HATTRIX CLEAR SG

Image scale 1:1

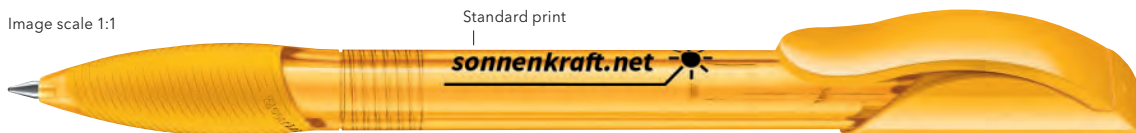

Your desired PMS colour  
available from 20,000 pieces  
(Surcharge 1,000 €)

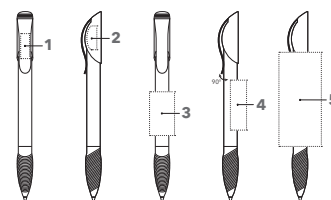

## ART. NO. 2339

### Push ball pen

Glossy transparent body surface, upper part and clip polished, coloured soft grip, senator® magic flow G2 refill (1.0 mm), ink colour: blue or black

### SERVICES

**PMS Service:** from 20,000 pieces, see page 101

## INDUSTRIAL PRICES (€/PC.)

RSP in euro, per piece, VAT not included.

2339	500	1,000	2,500	5,000
<b>Plain</b>	0.51	0.48	0.45	0.43
<b>Incl. 1c standard print, 1 position</b>	0.71	0.63	0.57	0.54
Each further colour	0.20	0.15	0.12	0.11

For branding prices please refer to page 113

## BRANDING / AREA

<b>Clip</b>	<b>1</b>	Standard print	20 x 7 mm
	<b>2</b>	Standard print	10 x 7 mm or 19 x 4 mm
<b>Barrel</b>	<b>3</b>	Standard print	35 x 20 mm
	<b>4</b>	Standard print	40 x 13 mm
	<b>5</b>	Standard print (from 1,000 pieces)	75 x 33.9 mm

# HATTRIX CLEAR SG MC

Image scale 1:1



Your desired PMS colour  
available from 20,000 pieces  
(Surcharge 1,000 €)

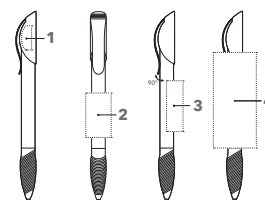

## ART. NO. 2419

### Push ball pen

Glossy transparent body surface, upper part polished, coloured soft grip zone to match the barrel, metal clip, senator® magic flow G2 refill (1.0 mm), ink colour: blue or black

### SERVICES

**PMS Service:** from 20,000 pieces, see page 101

## INDUSTRIAL PRICES (€/PC.)

RSP in euro, per piece, VAT not included.

2419	500	1,000	2,500	5,000
<b>Plain</b>	0.61	0.58	0.55	0.53
<b>Incl. 1c standard print, 1 position</b>	0.81	0.73	0.67	0.64
Each further colour	0.20	0.15	0.12	0.11

For branding prices please refer to page 113

## BRANDING / AREA

<b>Upper</b>	<b>1</b>	Standard print	10 x 7 mm or 19 x 4 mm
			1 colour
<b>Barrel</b>	<b>2</b>	Standard print	35 x 20 mm
	<b>3</b>	Standard print	40 x 13 mm
	<b>4</b>	Standard print (from 1,000 pieces)	75 x 33.9 mm

# HATTRIX POLISHED BASIC SG

Image scale 1:1

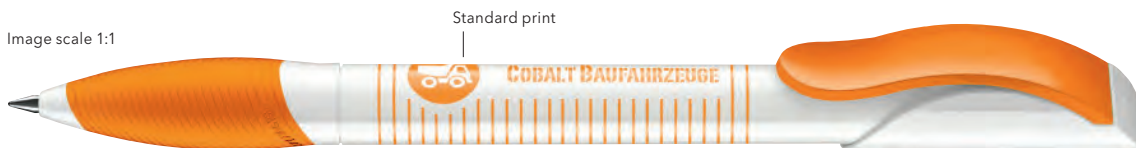

Your desired PMS colour available from 20,000 pieces (Surcharge 1,000 €)

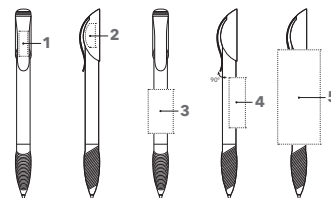

## ART. NO. 3200

### Push ball pen

Glossy opaque body and clip surface, white barrel, coloured clip and soft grip zone, senator® magic flow G2 refill (1.0 mm), ink colour: blue or black

### SERVICES

**PMS Service:** from 20,000 pieces, see page 101

## INDUSTRIAL PRICES (€/PC.)

RSP in euro, per piece, VAT not included.

	500	1,000	2,500	5,000
<b>3200</b>				
<b>Plain</b>	0.49	0.46	0.43	0.41
<b>Incl. 1c standard print, 1 position</b>	0.69	0.61	0.55	0.52
Each further colour	0.20	0.15	0.12	0.11

For branding prices please refer to page 113

## BRANDING / AREA

<b>Clip</b>	<b>1</b>	Standard print	20 x 7 mm
	<b>2</b>	Standard print	10 x 7 mm or 19 x 4 mm
<b>Barrel</b>	<b>3</b>	Standard print	35 x 20 mm
	<b>4</b>	Standard print	40 x 13 mm
	<b>5</b>	Standard print (from 1,000 pieces)	75 x 33.9 mm

# HATTRIX POLISHED BASIC SG MC

Image scale 1:1



Your desired PMS colour available from 20,000 pieces (Surcharge 1,000 €)

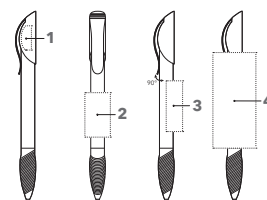

## ART. NO. 3201

### Push ball pen

Glossy opaque body, white barrel, metal clip and coloured soft grip zone, senator® magic flow G2 refill (1.0 mm), ink colour: blue or black

### SERVICES

**PMS Service:** from 20,000 pieces, see page 101

## INDUSTRIAL PRICES (€/PC.)

RSP in euro, per piece, VAT not included.

	500	1,000	2,500	5,000
<b>3201</b>				
<b>Plain</b>	0.59	0.56	0.53	0.51
<b>Incl. 1c standard print, 1 position</b>	0.79	0.71	0.65	0.62
Each further colour	0.20	0.15	0.12	0.11

For branding prices please refer to page 113

## BRANDING / AREA

<b>Upper</b>	<b>1</b>	Standard print	10 x 7 mm or 19 x 4 mm
			1 colour
<b>Barrel</b>	<b>2</b>	Standard print	35 x 20 mm
	<b>3</b>	Standard print	40 x 13 mm
	<b>4</b>	Standard print (from 1,000 pieces)	75 x 33.9 mm

# NEW SPRING CLEAR MC

Image scale 1:1

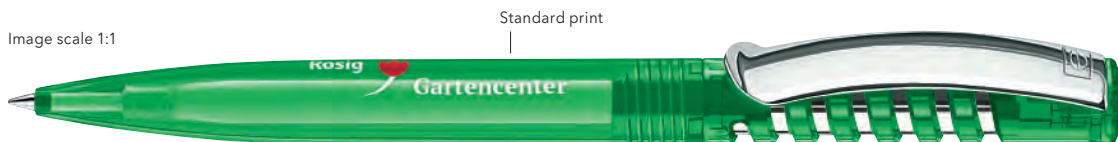

Your desired PMS colour available from 20,000 pieces (Surcharge 1,000 €)



reddot design award

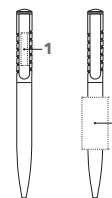

## ART. NO. 2410

### Push ball pen

Glossy opaque body surface, metallised inner push-button, metal clip, senator® magic flow G2 refill (1.0 mm), ink colour: blue or black

### SERVICES

**PMS Service:** from 20,000 pieces, see page 101

## INDUSTRIAL PRICES (€/PC.)

RSP in euro, per piece, VAT not included.

2410	250	500	1,000	2,500
<b>Plain</b>	1.00	0.94	0.88	0.84
<b>Incl. 1c standard print, 1 position</b>	1.30	1.14	1.03	0.96
Each further colour	0.30	0.20	0.15	0.12
<b>Incl. laser engraving</b>	1.70	1.54	1.43	1.36

For branding prices please refer to page 113

## BRANDING / AREA

Clip	1	Laser engraving	30 x 6 mm
<b>Barrel</b>	2	Standard print	40 x 20 mm

# NEW SPRING POLISHED MC

Image scale 1:1

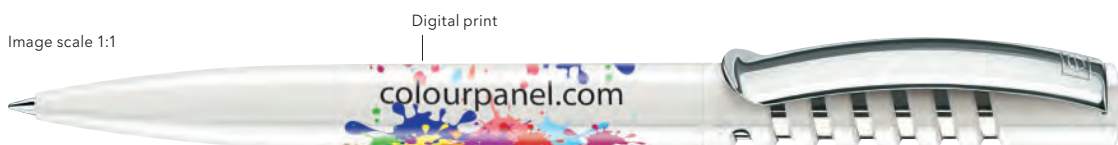

Your desired PMS colour available from 20,000 pieces (Surcharge 1,000 €)



reddot design award

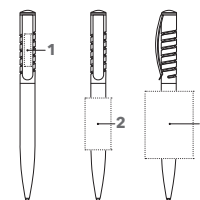

## ART. NO. 2310

### Push ball pen

Glossy opaque body surface, metallised inner push-button, metal clip, senator® magic flow G2 refill (1.0 mm), ink colour: blue or black

### SERVICES

**PMS Service:** from 20,000 pieces, see page 101

## INDUSTRIAL PRICES (€/PC.)

RSP in euro, per piece, VAT not included.

2310	250	500	1,000	2,500
<b>Plain</b>	0.98	0.92	0.86	0.82
<b>Incl. 1c standard print, 1 position</b>	1.28	1.12	1.01	0.94
Each further colour	0.30	0.20	0.15	0.12
<b>Incl. Laser engraving, 1 position</b>	1.68	1.52	1.41	1.34

For branding prices please refer to page 113

## BRANDING / AREA

Clip	1	Laser engraving	30 x 6 mm
<b>Barrel</b>	2	Standard print	40 x 20 mm
	3	Digital print on white barrel (from 1,000 pieces)	51 x 37 mm

# SOFTSPRING POLISHED

Image scale 1:1

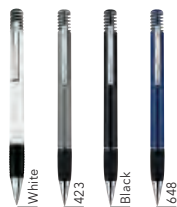

Your desired PMS colour available from 20,000 pieces (Surcharge 1,000 €)

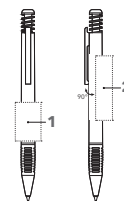

## ART. NO. 2067

### Push ball pen

Glossy opaque body surface with metallic pigments (except for white and black), metallised tip and spring, black soft grip zone, metal clip, senator® magic flow G2 refill (1.0 mm), ink colour: blue or black

### SERVICES

**PMS Service:** from 20,000 pieces, see page 101

## INDUSTRIAL PRICES (€/PC.)

RSP in euro, per piece, VAT not included.

	250	500	1,000	2,500
<b>2067</b>				
<b>Plain</b>	1.21	1.12	1.05	0.98
<b>Incl. 1c standard print, 1 position</b>	1.51	1.32	1.20	1.10
Each further colour	0.30	0.20	0.15	0.12

For branding prices please refer to page 113

## BRANDING / AREA

Barrel		
1	Standard print	30 x 20 mm
2	Standard print	50 x 13 mm

# DUO PEN POLISHED

Image scale 1:1

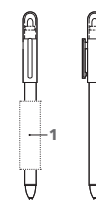
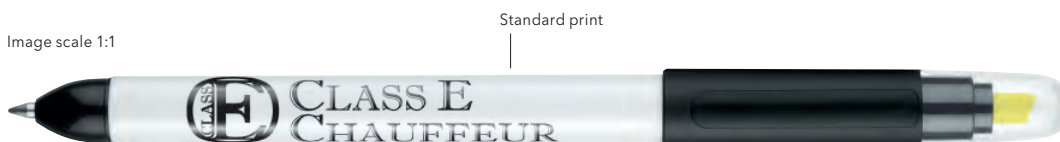

## ART. NO. 2122

### Twist ball pen

Glossy opaque body surface, combination of ball pen with black ink and yellow highlighter.

This item will be discontinued and is still available as long as stocks last.

## INDUSTRIAL PRICES (€/PC.)

RSP in euro, per piece, VAT not included.

	250	500	1,000	2,500
<b>2122</b>				
<b>Plain</b>	0,85	0,81	0,77	0,74
<b>Incl. 1c standard print, 1 position</b>	1,15	1,01	0,92	0,86

For branding prices please refer to page 113

## BRANDING / AREA

Barrel		
1	Standard print	50 x 15 mm 1 colour

## PHENIX

# SYMPATHETIC CHARACTER. BRILLIANT PERFORMANCE.

The metal twist ball pen in a high-quality piano lacquer look exudes an incomparable charm and convinces with its shiny personality.



## PHENIX BALL PEN

Image scale 1:1



Standard print



Corresponding cases

ET 150  
ET 154  
ET 156  
ET 157  
ET 160  
ET 169  
ET 190

see pages 71 -73



### ART. NO. 3380

#### Twist ball pen

Barrel: Metal, glossy lacquered  
Fittings: Metal, gun metal  
senator® magic flow metal refill, G2  
Ink colour: blue

### INDUSTRIAL PRICES (€/PC.)

RSP in euro, per piece, VAT not included.

3380	50	100	250	500
<b>Plain</b>	5.73	5.21	5.01	4.81
<b>Incl. 1c standard print</b>	6.83	5.81	5.31	5.01
<b>Incl. laser engraving</b>	7.23	6.21	5.71	5.41

For branding prices please refer to page 113

### BRANDING / AREA

Cap		
1	Standard print	30 x 12 mm
2	Laser engraving	35 x 5 mm

**ARCTIC****REMARKABLY STRIKING.  
FASCINATINGLY CHARMING.**

Metal twist ball pen in an unusual guise. The pleasant imitation leather with decorative stitching makes this ball pen a charming eye-catcher.

**ARCTIC  
BALL PEN**

Image scale 1:1



Laser engraving



Black

Corresponding cases

ET 150  
ET 154  
ET 156  
ET 157  
ET 160  
ET 190

see pages 71 - 73

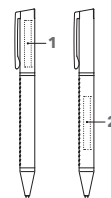

With the refill retracted,  
the branding will appear in  
line with the clip, with the  
stitching on the reverse.

**ART. NO. 3390****Twist ball pen**

Barrel: Metal, synthetic leather  
Fittings: Metal, glossy gun metal  
senator® magic flow metal refill, G2  
Ink colour: blue

**INDUSTRIAL PRICES (€/PC.)**

RSP in euro, per piece, VAT not included.

3390	50	100	250	500
Plain	5.28	4.80	4.65	4.50
Incl. laser engraving 1 position	6.78	5.80	5.35	5.10

For branding prices please refer to page 113

**BRANDING / AREA**

Cap	1	Laser engraving	35 x 5 mm
Barrel	2	Laser engraving	40 x 5 mm



# ARVENT GLOSSY BALL PEN



Image scale 1:1



Standard print



Corresponding cases

- ET 169
- ET 171
- ET 160
- ET 154
- ET 157
- ET 190

see pages 71-73

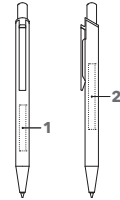

## ART. NO. 3360

### Push ball pen

Barrel: Metal, glossy lacquered  
 Fittings: Metal, glossy chrome  
 senator® magic flow metal refill, G2  
 Ink colour: blue

## INDUSTRIAL PRICES (€/PC.)

RSP in euro, per piece, VAT not included.

3360	100	250	500	1,000
<b>Plain</b>	1.64	1.57	1.52	1.47
<b>Incl. 1c standard print, 1 position</b>	2.24	1.87	1.72	1.62
<b>Incl. laser engraving 1 position</b>	2.64	2.27	2.12	2.02

For branding prices please refer to page 113

## BRANDING / AREA

Barrel		
1	Standard print	35 x 15 mm
	Laser engraving	35 x 5 mm
2	Standard print	50 x 11 mm
	Laser engraving	35 x 5 mm

# ARVENT SOFT TOUCH BALL PEN



Image scale 1:1

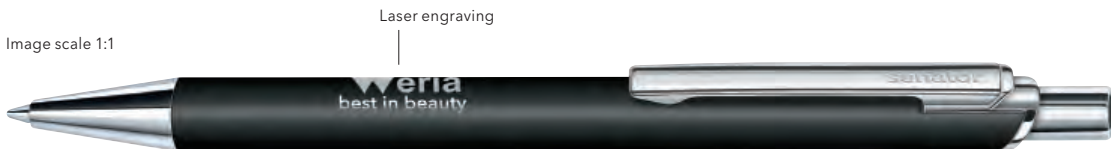

Laser engraving



Corresponding cases

- ET 169
- ET 171
- ET 160
- ET 154
- ET 157
- ET 190

see pages 71-73

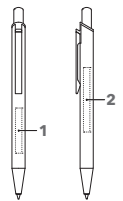

## ART. NR. 3365

### Push ball pen

Barrel: Metal, soft lacquer  
 Fittings: Metal, glossy chrome  
 senator® magic flow refill, G2 (1.0 mm)  
 Ink colour: blue

## INDUSTRIAL PRICES (€/PC.)

RSP in euro, per piece, VAT not included.

3365	100	250	500	1,000
<b>Plain</b>	1.79	1.72	1.67	1.62
<b>Incl. laser engraving, 1 position</b>	2.79	2.42	2.27	2.17

For branding prices please refer to page 113

## BRANDING / AREA

Barrel		
1	Laser engraving	35 x 5 mm
	Laser engraving	50 x 5 mm

# ATTRACT SOFT TOUCH BALL PEN / TOUCH PAD PEN

Image scale 1:1



Laser engraving



Corresponding cases

- ET 154
- ET 157
- ET 160
- ET 169
- ET 171
- ET 190

see pages 71-73

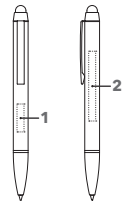

## ART. NO. 3335

### Twist ball pen with Touch Pad function

Barrel: Metal, soft lacquered  
Fittings: Metal, black lacquered  
senator® magic flow metal refill, G2  
Ink colour: blue

## INDUSTRIAL PRICES (€/PC.)

RSP in euro, per piece, VAT not included.

3335	100	250	500	1,000
<b>Plain</b>	2.94	2.83	2.75	2.67
<b>Incl. laser engraving 1 position</b>	3.94	3.53	3.35	3.22

For branding prices please refer to page 113

## BRANDING / AREA

Barrel		
1	Laser engraving	20 x 5 mm
2	Laser engraving	50 x 5 mm

# ATTRACT STYLUS BALL PEN / TOUCH PAD PEN

Image scale 1:1



Standard print



Corresponding cases

- ET 154
- ET 157
- ET 160
- ET 169
- ET 171
- ET 190

see pages 71-73

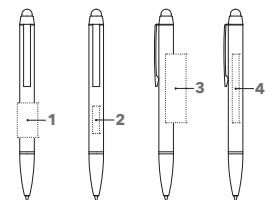

## ART. NO. 3330

### Twist ball pen with Touch Pad function

Barrel: Metal, glossy lacquered  
Fittings: Metal, black lacquered  
senator® magic flow metal refill, G2  
Ink colour: blue

## INDUSTRIAL PRICES (€/PC.)

RSP in euro, per piece, VAT not included.

3330	100	250	500	1,000
<b>Plain</b>	2.79	2.68	2.60	2.52
<b>Incl. 1c standard print, 1 position</b>	3.39	2.98	2.80	2.67
<b>Incl. laser engraving, 1 position</b>	3.79	3.38	3.20	3.07

For branding prices please refer to page 113

## BRANDING / AREA

Barrel		
1	Standard print	25 x 15 mm 1 colour
2	Laser engraving	20 x 5 mm
3	Standard print	50 x 15 mm 1 colour
4	Laser engraving	35 x 5 mm

## POLAR

# COOL LOOK MADE IN GERMANY.

This ball pen made in Germany combines a modern, linear design with exceptional quality at an unbeatably attractive price. A success all along the line.



## POLAR BALL PEN

Image scale 1:1

Standard print



Corresponding cases

ET 154  
ET 157  
ET 160  
ET 169  
ET 171  
ET 190

see pages 71-73

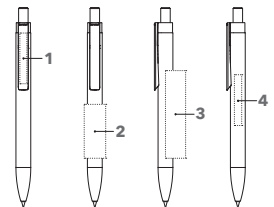

### ART. NR. 3260

#### Push ball pen

Barrel: Metal, varnished with coloured plastic clip holder

Fittings: Metal, glossy chrome

senator® magic flow G2 refill (1.0 mm)

Ink colour: blue

### INDUSTRIAL PRICES (€/PC.)

RSP in euro, per piece, VAT not included.

3260	100	250	500	1,000
Plain	1.98	1.92	1.82	1.76
Incl. 1c standard print, 1 position	2.58	2.22	2.02	1.91
Incl. laser engraving, 1 position	2.98	2.62	2.42	2.31

For branding prices please refer to page 113

### BRANDING / AREA

Clip	1	Laser engraving	45 x 6 mm
Barrel	2	Standard print	40 x 16 mm
		Laser engraving	45 x 5 mm
	3	Standard print	65 x 11 mm
	4	Laser engraving	60 x 5 mm

# POLAR MIX & MATCH



Image scale 1:1

Standard print



Corresponding cases

- ET 154
- ET 157
- ET 160
- ET 169
- ET 171
- ET 190

see pages 71 - 73

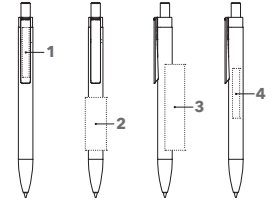

## ART. NO. 3261

### Push ball pen

Barrel: Metal, varnished  
Fittings: Metal, glossy chrome  
senator® magic flow G2 refill (1.0 mm)  
Ink colour: blue or black

### SERVICES

#### PMS Service:

(Clip holder):  
from 10,000 pieces, see page 101

#### Additional refill option:

senator® magic flow G2 refill (1.4 mm),  
see page 106

## INDUSTRIAL PRICES (€/PC.)

RSP in euro, per piece, VAT not included.

3261	100	250	500	1,000
<b>Plain</b>	2.01	1.95	1.85	1.79
<b>Incl. 1c standard print, 1 position</b>	2.61	2.25	2.05	1.94
<b>Incl. laser engraving, 1 position</b>	3.01	2.65	2.45	2.34
<b>Surcharge Magic Flow refill 1.4</b>	0.08	0.08	0.08	0.08

For branding prices please refer to page 113

## BRANDING / AREA

Clip	1	Laser engraving	45 x 6 mm
Barrel	2	Standard print	40 x 16 mm
		Laser engraving	45 x 5 mm
	3	Standard print	65 x 11 mm
	4	Laser engraving	60 x 5 mm

# GALANT BALL PEN



Image scale 1:1

Standard print



Corresponding cases

- ET 154
- ET 157
- ET 160
- ET 169
- ET 171
- ET 190

see pages 71 - 73

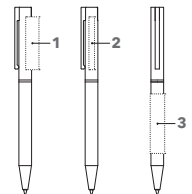

## ART. NO. 3370

### Twist ball pen

Barrel: Metal, glossy lacquered  
Fittings: Metal, glossy chrome  
senator® magic flow metal refill, G2  
Ink colour: blue

## INDUSTRIAL PRICES (€/PC.)

RSP in euro, per piece, VAT not included.

3370	100	250	500	1,000
<b>Plain</b>	2.99	2.87	2.78	2.70
<b>Incl. 1c standard print, 1 position</b>	3.59	3.17	2.98	2.85
<b>Incl. laser engraving, 1 position</b>	3.99	3.57	3.38	3.25

For branding prices please refer to page 113

## BRANDING / AREA

Upper	1	Standard print	30 x 10 mm 1 colour
Barrel	2	Laser engraving	40 x 5 mm
	3	Standard print	45 x 10 mm 2 colours
		Laser engraving	50 x 5 mm

# STAR TEC STEEL BALL PEN



Image scale 1:1



Standard print



Steel

Corresponding cases

- ET 150
- ET 154
- ET 156
- ET 157
- ET 160
- ET 169
- ET 190

see pages 71 - 73



6341

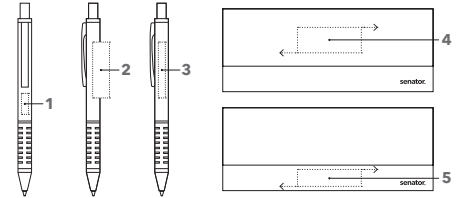

## ART. NO. 2040 / 6341

### Push ball pen 2040

Barrel: Metal, brushed  
 Fittings: Metal, glossy chrome  
 Soft grip zone: black  
 senator® magic flow metal refill, G2  
 Ink colour: blue

### Set 6341

Push ball pen 2040 + mechanical pencil 3004  
 in case ET 156, black

## INDUSTRIAL PRICES (€/PC.)

RSP in euro, per piece, VAT not included.

	100	250	500	1,000
<b>2040</b>				
Plain	1.90	1.78	1.70	1.65
Incl. 1c standard print, 1 position	2.50	2.08	1.90	1.80
Incl. laser engraving 1 position	2.90	2.48	2.30	2.20
<b>6341</b>	<b>50</b>	<b>100</b>	<b>250</b>	<b>500</b>
Plain	6.57	6.14	5.88	5.69
Incl. 1c standard print, 1 position	7.77	6.74	6.28	5.99
Incl. laser engraving 1 position	8.57	8.14	7.08	6.79

## BRANDING / AREA

Barrel		
1	Laser engraving	15 x 5 mm
2	Standard print	40 x 12 mm
3	Laser engraving	40 x 5 mm
Case		
4	Standard print	50 x 20 mm 1 colour
5	Standard print	50 x 15 mm 1 colour

For branding prices please refer to page 113

# STAR TEC STEEL MECHANICAL PENCIL



Image scale 1:1

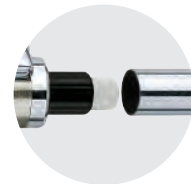

With eraser under push cap



Steel

Corresponding cases

- ET 150
- ET 154
- ET 156
- ET 157
- ET 160
- ET 169
- ET 190

see pages 71 - 73



6341

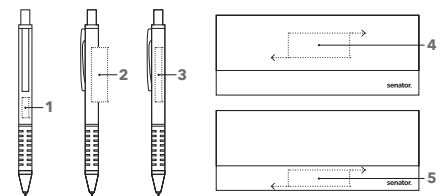

## ART. NO. 3004 / 6341

### Mechanical Pencil 3004

Barrel: Metal, brushed  
 Fittings: Metal, glossy chrome  
 Soft grip zone: black  
 0.5 mm Hi-Polymer pencil lead

### Set 6341

Push ball pen 2040 + mechanical pencil 3004  
 in case ET 156, black

## INDUSTRIAL PRICES (€/PC.)

RSP in euro, per piece, VAT not included.

	100	250	500	1,000
<b>3004</b>				
Plain	2.35	2.21	2.10	2.04
Incl. 1c standard print, 1 position	2.95	2.51	2.30	2.19
Incl. laser engraving 1 position	3.35	2.91	2.70	2.59
<b>6341</b>	<b>100</b>	<b>250</b>	<b>500</b>	<b>1,000</b>
Plain	6.14	5.88	5.69	5.58
Incl. 1c standard print, 1 position	7.34	6.28	5.99	5.82
Incl. laser engraving 1 position	8.14	7.08	6.79	6.62

## BRANDING / AREA

Barrel		
1	Laser engraving	15 x 5 mm
2	Standard print	40 x 12 mm
3	Laser engraving	40 x 5 mm
Case		
4	Standard print	50 x 20 mm 1 colour
5	Standard print	50 x 15 mm 1 colour

For branding prices please refer to page 113

# STAR TEC ALU BALL PEN



Image scale 1:1



Standard print



Corresponding cases

- ET 150
- ET 154
- ET 156
- ET 157
- ET 160
- ET 169
- ET 190

see pages 71 - 73



6342

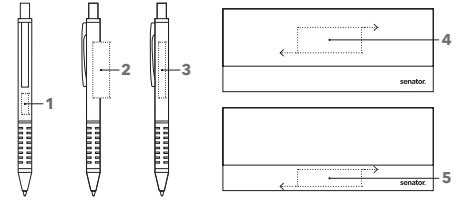

## ART. NO. 2511 / 6342

### Push ball pen 2511

Barrel: Metal, lacquered  
 Fittings: Metal, glossy chrome  
 Soft grip zone: black  
 senator® magic flow metal refill, G2  
 Ink colour: blue

### Set 6342

Push ball pen 2511 + mechanical pencil 3111  
 in black case ET 156  
 Only available in anthracite.

## INDUSTRIAL PRICES (€/PC.)

RSP in euro, per piece, VAT not included.

	100	250	500	1,000
<b>2511</b>	<b>100</b>	<b>250</b>	<b>500</b>	<b>1,000</b>
Plain	2.00	1.89	1.79	1.73
Incl. 1c standard print, 1 position	2.60	2.19	1.99	1.88
Incl. laser engraving 1 position	3.00	2.59	2.39	2.28
<b>6342</b>	<b>50</b>	<b>100</b>	<b>250</b>	<b>500</b>
Plain	6.85	6.40	6.15	5.92
Incl. 1c standard print, 1 position	8.05	7.60	6.55	6.22
Incl. laser engraving 1 position	8.85	8.40	7.35	7.02

## BRANDING / AREA

Barrel			
1	Laser engraving	15 x 5 mm	
2	Standard print	40 x 12 mm	
3	Laser engraving	40 x 5 mm	
Case			
4	Standard print	50 x 20 mm	1 colour
5	Standard print	50 x 15 mm	1 colour

For branding prices please refer to page 113

# STAR TEC ALU MECHANICAL PENCIL



Image scale 1:1

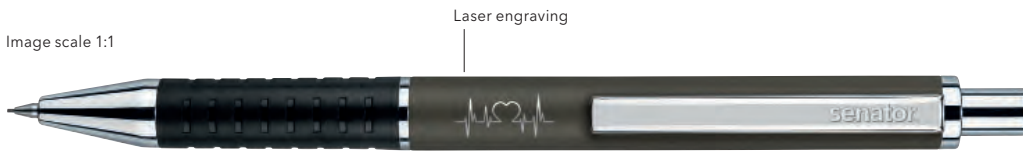

Laser engraving

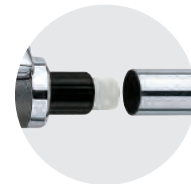

With eraser under push cap



Corresponding cases

- ET 150
- ET 154
- ET 156
- ET 157
- ET 160
- ET 169
- ET 190

see pages 71 - 73



6342

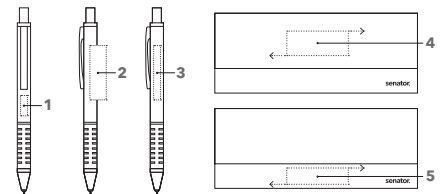

## ART. NO. 3111 / 6342

### Mechanical Pencil 3111

Barrel: Metal, lacquered  
 Fittings: Metal, glossy chrome  
 Soft grip zone: black  
 0.5 mm Hi-Polymer pencil lead

### Set 6342

Push ball pen 2511 + mechanical pencil 3111  
 in black case ET 156

## INDUSTRIAL PRICES (€/PC.)

RSP in euro, per piece, VAT not included.

	100	250	500	1,000
<b>3111</b>	<b>100</b>	<b>250</b>	<b>500</b>	<b>1,000</b>
Plain	2.51	2.37	2.24	2.18
Incl. 1c standard print, 1 position	3.11	2.67	2.44	2.33
Incl. laser engraving 1 position	3.51	3.07	2.84	2.73
<b>6342</b>	<b>100</b>	<b>250</b>	<b>500</b>	<b>1,000</b>
Plain	7.32	6.84	6.57	6.32
Incl. 1c standard print, 1 position	8.60	8.12	7.00	6.64
Incl. laser engraving 1 position	9.45	8.97	7.85	7.50

## BRANDING / AREA

Barrel			
1	Laser engraving	15 x 5 mm	
2	Standard print	40 x 12 mm	
3	Laser engraving	40 x 5 mm	
Case			
4	Standard print	50 x 20 mm	1 colour
5	Standard print	50 x 15 mm	1 colour

For branding prices please refer to page 113

This item will be discontinued and is still available as long as stocks last.

# DELGADO CLASSIC BALL PEN

PRINTED  
IN  
GERMANY

AS  
LONG AS  
STOCKS  
LAST

Image scale 1:1

Laser engraving



Corresponding cases

- ET 150
- ET 154
- ET 156
- ET 157
- ET 160
- ET 169
- ET 171
- ET 190

see pages 71 - 73



6101

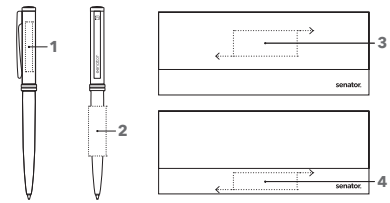

## ART. NO. 2240 / 6101

### Push ball pen 2240

Barrel: Metal, lacquered  
Fittings: Metal, gilt  
senator® magic flow metal refill, G2  
Ink colour: blue

### Set 6101

Push ball pen 2240 + rollerball 1030  
in black case ET 156

This item will be discontinued and is still available as long as stocks last.

## INDUSTRIAL PRICES (€/PC.)

RSP in euro, per piece, VAT not included.

	100	250	500	1,000
<b>2240</b>				
Plain	1.98	1.87	1.78	1.72
Incl. 1c standard print, 1 position	2.58	2.17	1.98	1.87
Incl. laser engraving 1 position	2.98	2.57	2.38	2.27
<b>6101</b>	<b>50</b>	<b>100</b>	<b>250</b>	<b>500</b>
Plain	7.90	7.35	7.04	6.79
Incl. 1c standard print, 1 position	9.10	8.55	7.44	7.09
Incl. laser engraving 1 position	9.90	9.35	8.24	7.89

## BRANDING / AREA

Part	Position	Branding Type	Dimensions
Cap	1	Standard print	35 x 5 mm 1 colour
		Laser engraving	35 x 5 mm
Barrel	2	Standard print	35 x 12 mm 1 colour
		Laser engraving	35 x 5 mm
Case	3	Standard print	50 x 20 mm 1 colour
	4	Standard print	50 x 15 mm 1 colour

For branding prices please refer to page 113

# DELGADO CLASSIC ROLLERBALL

PRINTED  
IN  
GERMANY

AS  
LONG AS  
STOCKS  
LAST

Image scale 1:1

Laser engraving

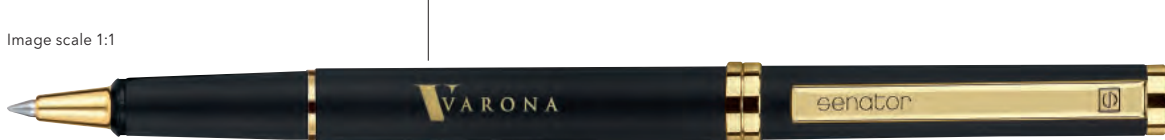

Corresponding cases

- ET 150
- ET 154
- ET 156
- ET 157
- ET 160
- ET 169
- ET 171
- ET 190

see pages 71 - 73



6101

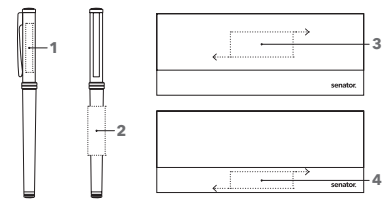

## ART. NO. 1030 / 6101

### Rollerball 1030

Barrel: Metal, lacquered  
Fittings: Metal, gilt  
Plastic safety rollerball refill  
Ink colour: blue

### Set 6101

Push ball pen 2240 + rollerball 1030  
in black case ET 156

This item will be discontinued and is still available as long as stocks last.

## INDUSTRIAL PRICES (€/PC.)

RSP in euro, per piece, VAT not included.

	100	250	500	1,000
<b>1030</b>				
Plain	3.48	3.28	3.12	3.02
Incl. 1c standard print, 1 position	4.08	3.58	3.32	3.17
Incl. laser engraving 1 position	4.48	3.98	3.72	3.57
<b>6101</b>	<b>50</b>	<b>100</b>	<b>250</b>	<b>500</b>
Plain	7.90	7.35	7.04	6.79
Incl. 1c standard print, 1 position	9.10	8.55	7.44	7.09
Incl. laser engraving 1 position	9.90	9.35	8.24	7.89

## BRANDING / AREA

Part	Position	Branding Type	Dimensions
Cap	1	Standard print	35 x 5 mm 1 colour
		Laser engraving	35 x 5 mm
Barrel	2	Standard print	35 x 12 mm 1 colour
		Laser engraving	35 x 5 mm
Case	3	Standard print	50 x 20 mm 1 colour
	4	Standard print	50 x 15 mm 1 colour

For branding prices please refer to page 113

# DELGADO CLASSIC STEEL BALL PEN

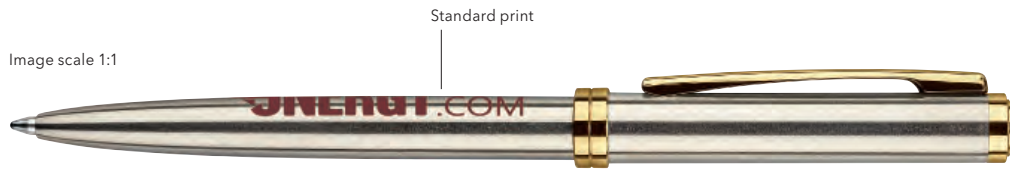

Image scale 1:1

PRINTED IN GERMANY

AS LONG AS STOCKS LAST



Corresponding cases

- ET 150
- ET 154
- ET 156
- ET 157
- ET 160
- ET 169
- ET 171
- ET 190

see pages 71 - 73



6100

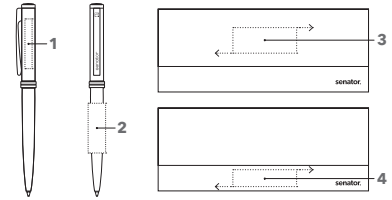

## ART. NO. 2239 / 6100

### Push ball pen 2239

Barrel: Metal, stainless steel finish  
Fittings: Metal, gilt  
senator® magic flow metal refill, G2  
Ink colour: blue

### Set 6100

Push ball pen 2239 + rollerball 1029  
in black case ET 156

This item will be discontinued and is still available as long as stocks last.

## INDUSTRIAL PRICES (€/PC.)

RSP in euro, per piece, VAT not included.

	100	250	500	1,000
<b>2239</b>	1.88	1.77	1.69	1.64
<b>Plain</b>				
<b>Incl. 1c standard print, 1 position</b>	2.48	2.07	1.89	1.79
<b>Incl. laser engraving 1 position</b>	2.88	2.47	2.29	2.19
<b>6100</b>	50	100	250	500
<b>Plain</b>	7.57	7.05	6.75	6.52
<b>Incl. 1c standard print, 1 position</b>	8.77	8.25	7.15	6.82
<b>Incl. laser engraving 1 position</b>	9.57	9.05	7.95	7.62

## BRANDING / AREA

Part	Position	Area	Dimensions
Cap	1	Standard print	35 x 5 mm 1 colour
		Laser engraving	35 x 5 mm
Barrel	2	Standard print	35 x 12 mm 1 colour
		Laser engraving	35 x 5 mm
Case	3	Standard print	50 x 20 mm 1 colour
	4	Standard print	50 x 15 mm 1 colour

For branding prices please refer to page 113

# DELGADO CLASSIC STEEL ROLLERBALL



Image scale 1:1

PRINTED IN GERMANY

AS LONG AS STOCKS LAST



Corresponding cases

- ET 150
- ET 154
- ET 156
- ET 157
- ET 160
- ET 169
- ET 171
- ET 190

see pages 71 - 73



6100

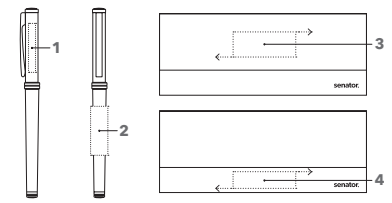

## ART. NO. 1029 / 6100

### Rollerball 1029

Barrel: Metal, stainless steel finish  
Fittings: Metal, gilt  
Plastic safety rollerball refill  
Ink colour: blue

### Set 6100

Push ball pen 2239 + rollerball 1029  
in black case ET 156

This item will be discontinued and is still available as long as stocks last.

## INDUSTRIAL PRICES (€/PC.)

RSP in euro, per piece, VAT not included.

	100	250	500	1,000
<b>1029</b>	3.28	3.09	2.94	2.85
<b>Plain</b>				
<b>Incl. 1c standard print, 1 position</b>	3.88	3.39	3.14	3.00
<b>Incl. laser engraving 1 position</b>	4.28	3.79	3.54	3.40
<b>6100</b>	50	100	250	500
<b>Plain</b>	7.57	7.05	6.75	6.52
<b>Incl. 1c standard print, 1 position</b>	8.77	8.25	7.15	6.82
<b>Incl. laser engraving 1 position</b>	9.57	9.05	7.95	7.62

## BRANDING / AREA

Part	Position	Area	Dimensions
Cap	1	Standard print	35 x 5 mm 1 colour
		Laser engraving	35 x 5 mm
Barrel	2	Standard print	35 x 12 mm 1 colour
		Laser engraving	35 x 5 mm
Case	3	Standard print	50 x 20 mm 1 colour
	4	Standard print	50 x 15 mm 1 colour

For branding prices please refer to page 113



# DELGADO METALLIC BALL PEN

PRINTED  
IN  
GERMANY

AS  
LONG AS  
STOCKS  
LAST



Image scale 1:1



Corresponding cases

- ET 150
- ET 154
- ET 156
- ET 157
- ET 160
- ET 169
- ET 171
- ET 190

see pages 71 - 73



6102

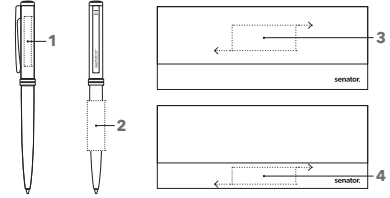

## ART. NO. 2241 / 6102

### Push ball pen 2241

Barrel: Metal, lacquered  
Fittings: Metal, glossy chrome  
senator® metal refill G2  
Ink colour: blue

### Set 6102

Push ball pen 2241 + rollerball 1031  
in black case ET 156

This item will be discontinued and is still available as long as stocks last.

## INDUSTRIAL PRICES (€/PC.)

RSP in euro, per piece, VAT not included.

	100	250	500	1,000
<b>2241</b>				
Plain	1.98	1.87	1.78	1.72
Incl. 1c standard print, 1 position	2.58	2.17	1.98	1.87
Incl. laser engraving 1 position	2.98	2.57	2.38	2.27
<b>6102</b>				
Plain	7.90	7.35	7.04	6.79
Incl. 1c standard print, 1 position	9.10	8.55	7.44	7.09
Incl. laser engraving 1 position	9.90	9.35	8.24	7.89

## BRANDING / AREA

Part	Position	Area	Dimensions
Cap	1	Standard print	35 x 5 mm 1 colour
		Laser engraving	35 x 5 mm
Barrel	2	Standard print	35 x 12 mm 1 colour
		Laser engraving	35 x 5 mm
Case	3	Standard print	50 x 20 mm 1 colour
	4	Standard print	50 x 15 mm 1 colour

For branding prices please refer to page 113

# DELGADO METALLIC ROLLERBALL

PRINTED  
IN  
GERMANY

AS  
LONG AS  
STOCKS  
LAST



Image scale 1:1



- ET 150
- ET 154
- ET 156
- ET 157
- ET 160
- ET 169
- ET 171
- ET 190

see pages 71 - 73



6102

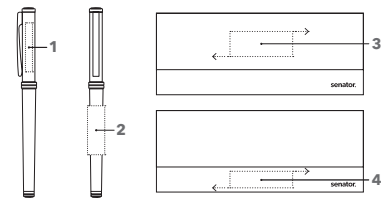

## ART. NO. 1031 / 6102

### Rollerball 1031

Barrel: Metal, lacquered  
Fittings: Metal, glossy chrome  
Plastic safety rollerball refill  
Ink colour: blue

### Set 6102

Push ball pen 2241 + rollerball 1031  
in black case ET 156

This item will be discontinued and is still available as long as stocks last.

## INDUSTRIAL PRICES (€/PC.)

RSP in euro, per piece, VAT not included.

	100	250	500	1,000
<b>1031</b>				
Plain	3.48	3.28	3.12	3.02
Incl. 1c standard print, 1 position	4.08	3.58	3.32	3.17
Incl. laser engraving 1 position	4.48	3.98	3.72	3.57
<b>6102</b>				
Plain	7.90	7.35	7.04	6.79
Incl. 1c standard print, 1 position	9.10	8.55	7.44	7.09
Incl. laser engraving 1 position	9.90	9.35	8.24	7.89

## BRANDING / AREA

Part	Position	Area	Dimensions
Cap	1	Standard print	35 x 5 mm 1 colour
		Laser engraving	35 x 5 mm
Barrel	2	Standard print	35 x 12 mm 1 colour
		Laser engraving	35 x 5 mm
Case	3	Standard print	50 x 20 mm 1 colour
	4	Standard print	50 x 15 mm 1 colour

For branding prices please refer to page 113

# DELGADO STEEL BALL PEN



Image scale 1:1

Standard print



Corresponding cases

- ET 150
- ET 154
- ET 156
- ET 157
- ET 160
- ET 169
- ET 171
- ET 190

see pages 71-73

6114

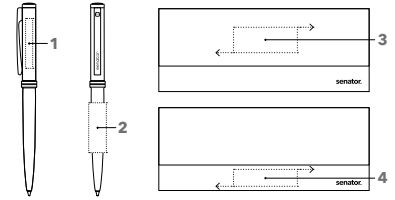

## ART. NO. 2242 / 6114

### Push ball pen 2242

Barrel: Metal, stainless steel finish  
Fittings: Metal glossy chrome  
senator® magic flow metal refill, G2  
Ink colour: blue

### Set 6114

Push ball pen 2242 + rollerball 1039  
in black case ET 156

This item will be discontinued and is still available as long as stocks last.

## INDUSTRIAL PRICES (€/PC.)

RSP in euro, per piece, VAT not included.

	100	250	500	1,000
<b>2242</b>				
Plain	1.88	1.77	1.69	1.64
Incl. 1c standard print, 1 position	2.48	2.07	1.89	1.79
Incl. laser engraving 1 position	2.88	2.47	2.29	2.19
<b>6114</b>	<b>50</b>	<b>100</b>	<b>250</b>	<b>500</b>
Plain	7.57	7.05	6.75	6.52
Incl. 1c standard print, 1 position	8.77	8.25	7.15	6.82
Incl. laser engraving 1 position	9.57	9.05	7.95	7.62

## BRANDING / AREA

Part	Position	Branding	Dimensions
Cap	1	Standard print	35 x 5 mm 1 colour
		Laser engraving	35 x 5 mm
Barrel	2	Standard print	35 x 12 mm 1 colour
		Laser engraving	35 x 5 mm
Case	3	Standard print	50 x 20 mm 1 colour
	4	Standard print	50 x 15 mm 1 colour

For branding prices please refer to page 113

# DELGADO STEEL ROLLERBALL



Image scale 1:1

Standard print



Corresponding cases

- ET 150
- ET 154
- ET 156
- ET 157
- ET 160
- ET 169
- ET 171
- ET 190

see pages 71-73

6114

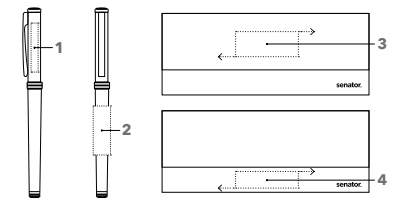

## ART. NO. 1039 / 6114

### Rollerball 1039

Barrel: Metal, stainless steel finish  
Fittings: Metal, glossy chrome  
Plastic safety rollerball refill  
Ink colour: blue

### Set 6114

Push ball pen 2242 + rollerball 1039  
in black case ET 156

This item will be discontinued and is still available as long as stocks last.

## INDUSTRIAL PRICES (€/PC.)

RSP in euro, per piece, VAT not included.

	100	250	500	1,000
<b>1039</b>				
Plain	3.28	3.09	2.94	2.85
Incl. 1c standard print, 1 position	3.88	3.39	3.14	3.00
Incl. laser engraving 1 position	4.28	3.79	3.54	3.40
<b>6114</b>	<b>50</b>	<b>100</b>	<b>250</b>	<b>500</b>
Plain	7.57	7.05	6.75	6.52
Incl. 1c standard print, 1 position	8.77	8.25	7.15	6.82
Incl. laser engraving 1 position	9.57	9.05	7.95	7.62

## BRANDING / AREA

Part	Position	Branding	Dimensions
Cap	1	Standard print	35 x 5 mm 1 colour
		Laser engraving	35 x 5 mm
Barrel	2	Standard print	35 x 12 mm 1 colour
		Laser engraving	35 x 5 mm
Case	3	Standard print	50 x 20 mm 1 colour
	4	Standard print	50 x 15 mm 1 colour

For branding prices please refer to page 113

# NAUTIC BLACK BALL PEN / TOUCH PAD PEN



Image scale 1:1



Laser engraving



Corresponding cases

- ET 150
- ET 154
- ET 156
- ET 157
- ET 160
- ET 169
- ET 171
- ET 190

see pages 71 - 73

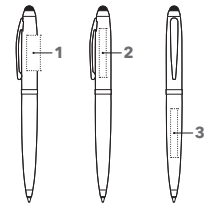

## ART. NO. 3340

### Twist ball pen with touch pad function

Barrel : Metal, glossy lacquer  
Fittings: Metal, gun metal  
senator® magic flow metal refill, G2  
Ink colour: blue

## INDUSTRIAL PRICES (€/PC.)

RSP in euro, per piece, VAT not included.

3340	50	100	250	500
<b>Plain</b>	6.50	5.91	5.59	5.33
<b>Incl. 1c standard print, 1 position</b>	7.60	6.51	5.89	5.53
<b>Incl. laser engraving, 1 position</b>	8.00	6.91	6.29	5.93

For branding prices please refer to page 113

## BRANDING / AREA

Cap	1	Standard print	25 x 10 mm 1 colour
	2	Laser engraving	35 x 5 mm
Barrel	3	Standard print	25 x 12mm 1 colour
		Laser engraving	35 x 5 mm

# NAUTIC BALL PEN / TOUCH PAD PEN



Image scale 1:1



Laser engraving



Corresponding cases

- ET 150
- ET 154
- ET 156
- ET 157
- ET 160
- ET 169
- ET 171
- ET 190

see pages 71 - 73



6297

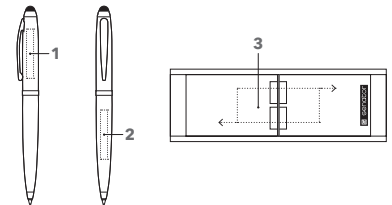

## ART. NO. 2754 / 6297

### Twist ball pen with touch pad function 2754

Barrel and fittings: Metal, glossy chrome  
Cap: Metal, soft lacquer  
senator® magic flow metal refill, G2  
Ink colour: blue

### Set 6297

Touch Pad Pen 2754 + rollerball 1092  
in case ET 171

## INDUSTRIAL PRICES (€/PC.)

RSP in euro, per piece, VAT not included.

2754	50	100	250	500
<b>Plain</b>	5.94	5.40	5.08	4.83
<b>Incl. 1c standard print, 1 position</b>	7.04	6.00	5.38	5.03
<b>Incl. laser engraving, 1 position</b>	7.44	6.40	5.78	5.43
6297	50	100	250	500
<b>Plain</b>	14.10	12.92	12.22	11.68
<b>Incl. 1c standard print, 1 position</b>	15.30	14.12	12.62	11.98
<b>Incl. laser engraving, 1 position</b>	16.10	14.92	13.42	12.78

## BRANDING / AREA

Cap	1	Laser engraving	35 x 5 mm
Barrel	2	Standard print	25 x 12 mm 1 colour
		Laser engraving	35 x 5 mm
Case	3	Standard print	60 x 25 mm 1 colour

For branding prices please refer to page 113

# NAUTIC BALL PEN

Image scale 1:1



Laser engraving



Corresponding cases

- ET 150
- ET 154
- ET 156
- ET 157
- ET 160
- ET 169
- ET 171
- ET 190

see pages 71 - 73

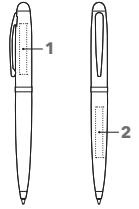

## ART. NO. 2215

### Twist ball pen

Barrel and fittings: Metal, glossy chrome  
Cap: Metal, soft lacquer  
senator® magic flow metal refill, G2  
Ink colour: blue

### SERVICES

Express Service (Online Portal): see page 102

## INDUSTRIAL PRICES (€/PC.)

RSP in euro, per piece, VAT not included.

2215	50	100	250	500
Plain	5.50	5.00	4.71	4.46
Incl. 1c standard print, 1 position	6.60	5.60	5.01	4.66
Incl. laser engraving, 1 position	7.00	6.00	5.41	5.06

For branding prices please refer to page 113

## BRANDING / AREA

Cap	1	Laser engraving	35 x 5 mm
Barrel	2	Laser engraving	35 x 5 mm
		Standard print	25 x 12 mm

# NAUTIC ROLLERBALL

Image scale 1:1



Standard print



Corresponding cases

- ET 150
- ET 154
- ET 156
- ET 157
- ET 160
- ET 169
- ET 171
- ET 190

see pages 71 - 73



6297

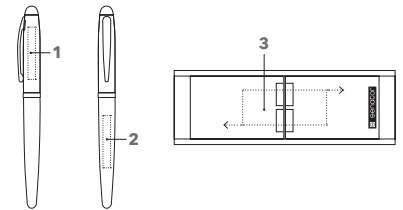

## ART. NO. 1092 / 6297

### Rollerball 1092

Barrel and fittings: Metal, glossy chrome  
Cap and grip zone: Metal, soft lacquer  
Metal safety rollerball refill  
Ink colour: blue

### Set 6297

Touch Pad Pen 2754 + rollerball 1092  
in case ET 171

### SERVICES

Express Service (Online Portal): see page 102

## INDUSTRIAL PRICES (€/PC.)

RSP in euro, per piece, VAT not included.

1092	50	100	250	500
Plain	7.05	6.41	6.03	5.74
Incl. 1c standard print, 1 position	8.15	7.01	6.33	5.94
Incl. laser engraving, 1 position	8.55	7.41	6.73	6.34
6297	50	100	250	500
Plain	14.10	12.92	12.22	11.68
Incl. 1c standard print, 1 position	15.30	14.12	12.62	11.98
Incl. laser engraving, 1 position	16.10	14.92	13.42	12.78

## BRANDING / AREA

Cap	1	Laser engraving	35 x 5 mm
Barrel	2	Laser engraving	35 x 5 mm
		Standard print	25 x 12 mm
Case	3	Standard print	60 x 25 mm 1 colour

For branding prices please refer to page 113

## IMAGE BLACK LINE

# MAKES YOUR IMAGE UNMISTAKABLE.

Clear lines, perfect style with a distinctive surface design. The Image Line presents itself in a perfect manner.



## IMAGE BLACK LINE BALL PEN

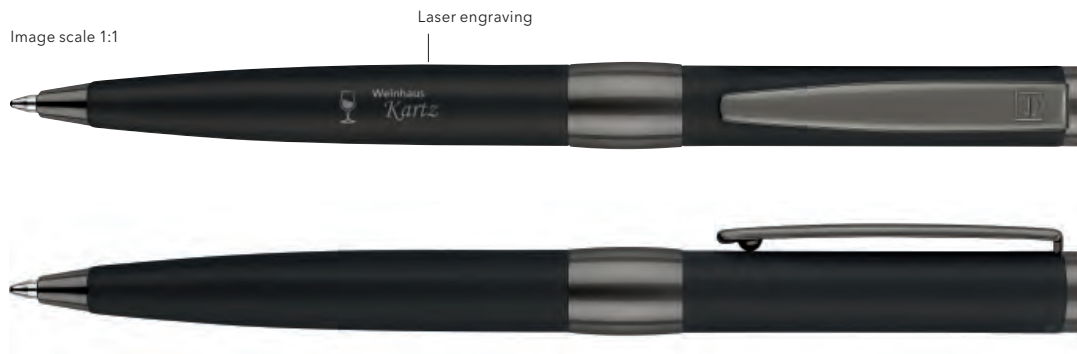

Image scale 1:1

Laser engraving



Corresponding cases

- ET 150
- ET 154
- ET 156
- ET 157
- ET 160
- ET 169
- ET 171
- ET 190

see pages 71 - 73



PROMOTIONAL GIFT  
AWARD 2010

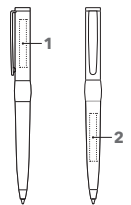

### ART. NO. 2636

#### Twist ball pen

Barrel: Metal, soft varnish  
Fittings: Metal, gun metal  
senator® magic flow metal refill, G2  
Ink colour: blue

#### SERVICES

Express Service (Online Portal): see page 102

### INDUSTRIAL PRICES (€/PC.)

RSP in euro, per piece, VAT not included.

2636	50	100	250	500
Plain	7.55	7.10	6.75	6.54
Incl. laser engraving, 1 position	9.05	8.10	7.45	7.14

For branding prices please refer to page 113

### BRANDING / AREA

Cap	1	Laser engraving	35 x 5 mm
Barrel	2	Laser engraving	35 x 5 mm

# IMAGE BLACK LINE ROLLERBALL

Image scale 1:1



Laser engraving



Black

Corresponding cases

- ET 150
- ET 154
- ET 156
- ET 157
- ET 160
- ET 169
- ET 171
- ET 190

see pages 71-73

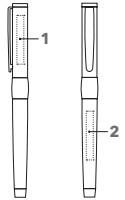

## ART. NO. 1119

### Rollerball

Barrel: Metal, soft varnish  
Fittings: Metal, gun metal  
Metal safety rollerball refill  
Ink colour: blue

### SERVICES

Express Service (Online Portal): see page 102

## INDUSTRIAL PRICES (€/PC.)

RSP in euro, per piece, VAT not included.

1119	50	100	250	500
Plain	8.75	8.23	7.82	7.58
Incl. laser engraving, 1 position	10.25	9.23	8.52	8.18

For branding prices please refer to page 113

## BRANDING / AREA

Cap	1	Laser engraving	35 x 5 mm
Barrel	2	Laser engraving	35 x 5 mm

# IMAGE BLACK LINE FOUNTAIN PEN

Image scale 1:1



Laser engraving



Black

Corresponding cases

- ET 150
- ET 154
- ET 156
- ET 157
- ET 160
- ET 169
- ET 171
- ET 190

see pages 71-73

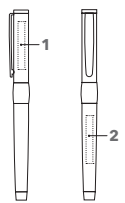

## ART. NO. 0104

### Fountain pen

Barrel: Metal, soft varnish  
Fittings: Metal gun metal  
Iridium-tipped stainless steel nib, M  
Standard ink cartridge  
Ink colour: blue

### SERVICES

Express Service (Online Portal): see page 102

## INDUSTRIAL PRICES (€/PC.)

RSP in euro, per piece, VAT not included.

0104	50	100	250	500
Plain	8.95	8.42	8.00	7.76
Incl. laser engraving, 1 position	10.45	9.42	8.70	8.36

For branding prices please refer to page 113

## BRANDING / AREA

Cap	1	Laser engraving	35 x 5 mm
Barrel	2	Laser engraving	35 x 5 mm

# IMAGE BLACK LINE SETS



6205  
6206

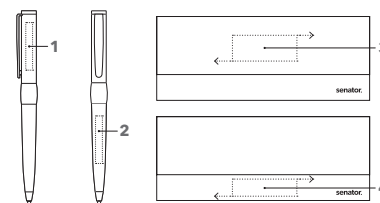

## ART. NO. 6205/6206

### Set 6205

Twist ball pen 2636 + fountain pen 0104  
in black case ET 156

### Set 6206

Twist ball pen 2636 + rollerball 1119  
in black case ET 156

### SERVICES

**Express Service (Online Portal):** see page 102

## INDUSTRIAL PRICES (€/PC.)

RSP in euro, per piece, VAT not included.

	25	50	100	250
<b>6205</b>				
<b>Plain</b>	20.05	18.39	17.41	16.64
<b>Incl. laser engraving, 1 position</b>	23.05	20.39	19.41	17.84
<b>6206</b>				
<b>Plain</b>	19.83	18.19	17.22	16.46
<b>Incl. laser engraving, 1 position</b>	22.83	20.19	19.22	17.66

## BRANDING / AREA

Part	Branding	Area
<b>Cap</b>	1 Laser engraving	35 x 5 mm
<b>Barrel</b>	2 Laser engraving	35 x 5 mm
<b>Case</b>	3 Standard print	50 x 20 mm 1 colour
	4 Standard print	50 x 15 mm 1 colour

# IMAGE BLACK LINE SETS



6151  
6179

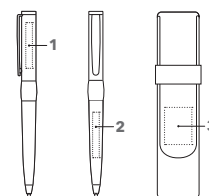

## ART. NO. 6151/6179

### Set 6151

Twist ball pen 2636 + fountain pen 0104  
in box SC 197 with leather wallet ET 150

### Set 6179

Twist ball pen 2636 + rollerball 1119 in  
box SC 197 with leather wallet ET 150

### SERVICES

**Express Service (Online Portal):** see page 102

## INDUSTRIAL PRICES (€/PC.)

RSP in euro, per piece, VAT not included.

	25	50	100	250
<b>6151</b>				
<b>Plain</b>	24.76	23.10	22.12	21.35
<b>Incl. laser engraving, 1 position</b>	27.76	25.10	24.12	22.55
<b>6179</b>				
<b>Plain</b>	24.54	22.90	21.93	21.17
<b>Incl. laser engraving, 1 position</b>	27.54	24.90	23.93	22.37

## BRANDING / AREA

Part	Branding	Area
<b>Cap</b>	1 Laser engraving	35 x 5 mm
<b>Barrel</b>	2 Laser engraving	35 x 5 mm
<b>Case</b>	3 Embossing	22 x 30 mm

# IMAGE WHITE LINE BALL PEN

Image scale 1:1



Corresponding cases

- ET 150
- ET 154
- ET 156
- ET 157
- ET 160
- ET 169
- ET 171
- ET 190

see pages 71 - 73



6267

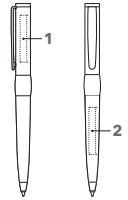

## ART. NO. 2786 / 6267

### Twist ball pen 2786

Barrel: metal, glossy lacquered  
Fittings: Glossy chrome  
senator® magic flow metal refill, G2  
Ink colour: blue

### Set 6267

Twist ball pen 2786 + rollerball 1146  
in white case ET 156

## INDUSTRIAL PRICES (€/PC.)

RSP in euro, per piece, VAT not included.

	50	100	250	500
<b>2786</b>				
Plain	7.55	7.10	6.75	6.54
Incl. 1c standard print, 1 position	8.65	7.70	7.05	6.74
Incl. laser engraving, 1 position	9.05	8.10	7.45	7.14
<b>6267</b>				
Plain	19.83	18.19	17.22	16.46
Incl. 1c standard print, 1 position	22.03	19.39	18.42	16.86
Incl. laser engraving, 1 position	22.83	20.19	19.22	17.66

## BRANDING / AREA

Part	Position	Branding	Dimensions
Cap	1	Laser engraving	35 x 5 mm
		Standard print	35 x 5 mm 1 colour
Barrel	2	Laser engraving	35 x 5 mm
		Standard print	35 x 5 mm 1 colour
		Standard print	20 x 12 mm 1 colour

For branding prices please refer to page 113

# IMAGE WHITE LINE ROLLERBALL

Image scale 1:1



Corresponding cases

- ET 150
- ET 154
- ET 156
- ET 157
- ET 160
- ET 169
- ET 171
- ET 190

see pages 71 - 73



6267

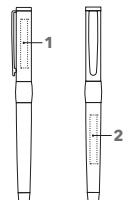

## ART. NO. 1146 / 6267

### Rollerball 1146

Barrel: metal, glossy lacquered  
Fittings: Glossy chrome  
Metal safety rollerball refill  
Ink colour: blue

### Set 6267

Twist ball pen 2786 + Rollerball 1146  
in white case ET 156

## INDUSTRIAL PRICES (€/PC.)

RSP in euro, per piece, VAT not included.

	50	100	250	500
<b>1146</b>				
Plain	8.75	8.23	7.82	7.58
Incl. 1c standard print, 1 position	9.85	8.83	8.12	7.78
Incl. laser engraving, 1 position	10.25	9.23	8.52	8.18
<b>6267</b>				
Plain	19.83	18.19	17.22	16.46
Incl. 1c standard print, 1 position	22.03	19.39	18.42	16.86
Incl. laser engraving, 1 position	22.83	20.19	19.22	17.66

## BRANDING / AREA

Part	Position	Branding	Dimensions
Cap	1	Laser engraving	35 x 5 mm
		Standard print	35 x 5 mm 1 colour
Barrel	2	Laser engraving	35 x 5 mm
		Standard print	35 x 5 mm 1 colour
		Standard print	20 x 12 mm 1 colour

For branding prices please refer to page 113



# IMAGE CHROME BALL PEN

Image scale 1:1



Corresponding cases

ET 150  
ET 154  
ET 156  
ET 157  
ET 160  
ET 169  
ET 171  
ET 181  
ET 190

see pages 71 - 73



6238



6089

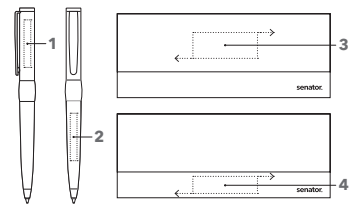

## ART. NO. 2158 / 6089 / 6238

### Twist ball pen 2158

Barrel: Metal, soft varnish, fittings: Metal, matt chrome, senator® magic flow metal refill, G2  
Ink colour: blue

### Set 6089

Twist ball pen 2158 + rollerball 1036  
in presentation box SC 197 with leather wallet ET 150

### Set 6238

Twist ball pen 2158 + rollerball 1036 in black case  
ET 156

### SERVICES

Express Service (Online Portal): see page 102

## INDUSTRIAL PRICES (€/PC.)

RSP in euro, per piece, VAT not included.

	50	100	250	500
<b>2158</b>				
Plain	7.55	7.10	6.75	6.54
Incl. laser engraving, 1 position	9.05	8.10	7.45	7.14
<b>6089</b>				
Plain	24.54	22.90	21.93	21.17
Incl. 1c standard print, 1 position	26.74	24.10	23.13	21.57
Incl. laser engraving, 1 position	27.54	24.90	23.93	22.37
<b>6238</b>				
Plain	19.83	18.19	17.22	16.46
Incl. laser engraving, 1 position	22.83	20.19	19.22	17.66

## BRANDING / AREA

Part	Position	Method	Dimensions
Cap	1	Laser engraving	35 x 5 mm
Barrel	2	Laser engraving	35 x 5 mm
Case	3	Standard print	50 x 20 mm 1 colour
	4	Standard print	50 x 15 mm 1 colour

For branding prices please refer to page 113

# IMAGE CHROME ROLLERBALL

Image scale 1:1



Corresponding cases

ET 150  
ET 154  
ET 156  
ET 157  
ET 160  
ET 169  
ET 171  
ET 181  
ET 190

see pages 71 - 73



6238



6089

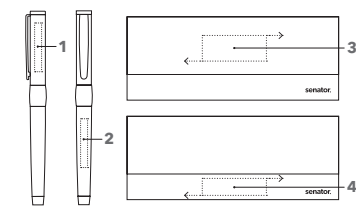

## ART. NO. 1036 / 6089 / 6238

### Rollerball 1036

Barrel: Metal, soft varnish, fittings: Metal, matt chrome, metal safety rollerball refill  
Ink colour: blue

### Set 6089

Twist ball pen 2158 + rollerball 1036 in presentation  
box SC 197 with leather wallet ET 150

### Set 6238

Twist ball pen 2158 + rollerball 1036 in black case  
ET 156

### SERVICES

Express Service (Online Portal): see page 102

## INDUSTRIAL PRICES (€/PC.)

RSP in euro, per piece, VAT not included.

	50	100	250	500
<b>1036</b>				
Plain	8.75	8.23	7.82	7.58
Incl. laser engraving, 1 position	10.25	9.23	8.52	8.18
<b>6089</b>				
Plain	24.54	22.90	21.93	21.17
Incl. 1c standard print, 1 position	26.74	24.10	23.13	21.57
Incl. laser engraving, 1 position	27.54	24.90	23.93	22.37
<b>6238</b>				
Plain	19.83	18.19	17.22	16.46
Incl. laser engraving, 1 position	22.83	20.19	19.22	17.66

## BRANDING / AREA

Part	Position	Method	Dimensions
Cap	1	Laser engraving	35 x 5 mm
Barrel	2	Laser engraving	35 x 5 mm
Case	3	Standard print	50 x 20 mm 1 colour
	4	Standard print	50 x 15 mm 1 colour

For branding prices please refer to page 113

## SIGNER LINER

### STRONG DESIGN FOR GREAT EFFECT.

The unique synthesis of design, high-quality material and eye-catching finishing options are the best prerequisites for expressive advertising messages.



## SIGNER LINER BALL PEN

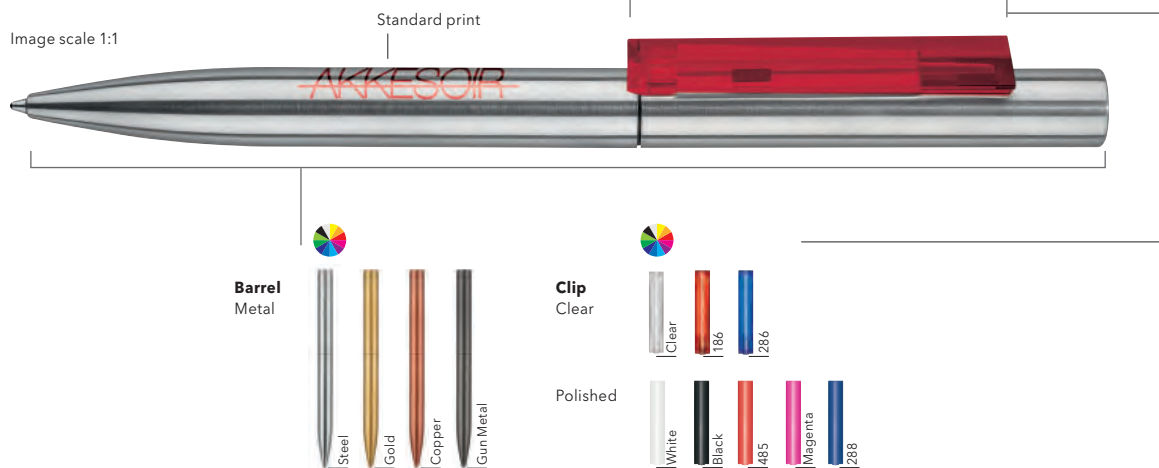
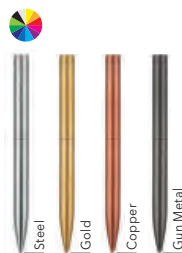
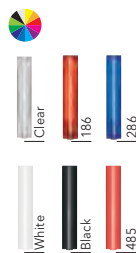

Image scale 1:1

#### Barrel Metal



#### Clip Clear



#### Polished



#### Corresponding cases

ET 150  
ET 154  
ET 156  
ET 157  
ET 160  
ET 169  
ET 171  
ET 190



reddot award

see pages 71 - 73

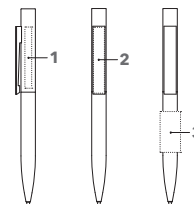

#### ART. NO. 2709

##### Twist ball pen

Barrel: Stainless steel, sandblasted or lacquered  
Clip: Plastic; clear or polished  
senator® magic flow G2 refill (1.0 mm)  
Ink colour: blue

#### INDUSTRIAL PRICES (€/PC.)

RSP in euro, per piece, VAT not included.

2709	50	100	250	500
<b>Plain</b>	5.52	5.02	4.82	4.77
<b>Incl. 1c standard print, 1 position</b>	6.62	5.62	5.12	4.97
<b>Incl. laser engraving, 1 position</b>	7.02	6.02	5.52	5.37
<b>Incl. digital print (CMYK), 1 motif</b>	6.77	5.77	5.27	5.12
<b>Surcharge metal refill G2</b>	0.28	0.28	0.28	0.28

For branding prices please refer to page 113

#### BRANDING / AREA

Cap	1	Standard print	45 x 5 mm 1 colour
		Laser engraving	35 x 6 mm
Clip	2	Standard print	47 x 7 mm
		Digital print	48,5 x 8 mm
Barrel	3	Standard print	30 x 15 mm 1 colour
		Laser engraving	40 x 6 mm

# CARBON BLACK BALL PEN



Laser engraving

Image scale 1:1



Carbon

Corresponding cases

- ET 150
- ET 154
- ET 157
- ET 160,
- ET 169
- ET 171
- ET 181
- ET 190

see pages 71 - 73



## ART. NO. 3350

### Twist ball pen

Barrel: Metal in combination with light carbon  
Fittings: Metal gun metal  
senator® magic flow metal refill, G2  
Ink colour: blue

## INDUSTRIAL PRICES (€/PC.)

RSP in euro, per piece, VAT not included.

3350	25	50	100	250
<b>Plain</b>	10.45	9.86	9.39	9.12
<b>Incl. 1c standard print, 1 position</b>	12.55	10.96	9.99	9.42
<b>Incl. laser engraving, 1 position</b>	12.95	11.36	10.39	9.82

For branding prices please refer to page 113

## BRANDING / AREA

Cap	1	Standard print	30 x 12 mm 1 colour
		Laser engraving	40 x 5 mm

# CARBON LINE BALL PEN



Standard print

Image scale 1:1



2159, 6239



Carbon

Corresponding cases

- ET 150
- ET 154
- ET 156
- ET 157
- ET 160
- ET 169
- ET 171
- ET 190

see pages 71 - 73



6239  
6240

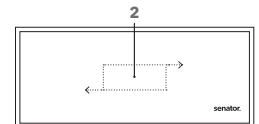

## ART. NO. 2159 / 6239 / 6240

### Twist ball pen 2159

Metal in combination with light carbon  
Cap, tip, fittings: Metal, matt chromesenator® magic flow metal refill, G2, ink colour: blue

### Set 6239

Twist ball pen 2159 + fountain pen 0076 in black case ET 160

### Set 6240

Twist ball pen 2159 + rollerball 1037 in black case ET 160

## SERVICES

Express Service (Online Portal): see page 102

## INDUSTRIAL PRICES (€/PC.)

RSP in euro, per piece, VAT not included.

2159	25	50	100	250
<b>Plain</b>	9.95	9.36	8.89	8.62
<b>Incl. 1c standard print, 1 position</b>	12.05	10.46	9.49	8.92
<b>Incl. laser engraving, 1 position</b>	12.45	10.86	9.89	9.32
<b>6239</b>	<b>10</b>	<b>25</b>	<b>50</b>	<b>100</b>
<b>Plain</b>	30.35	27.95	26.53	25.40
<b>Incl. 1c standard print, 1 position</b>	40.55	30.15	27.73	26.60
<b>Incl. laser engraving, 1 position</b>	41.35	30.95	28.53	27.40
<b>6240</b>	<b>10</b>	<b>25</b>	<b>50</b>	<b>100</b>
<b>Plain</b>	29.25	26.95	25.59	24.51
<b>Incl. 1c standard print, 1 position</b>	39.45	29.15	26.79	25.71
<b>Incl. laser engraving, 1 position</b>	40.25	29.95	27.59	26.51

## BRANDING / AREA

Cap	1	Standard print	30 x 12 mm 1 colour
		Laser engraving	40 x 5 mm

Case	2	Standard print	50 x 20 mm 1 colour
------	---	----------------	------------------------

For branding prices please refer to page 113

# CARBON LINE ROLLERBALL

Image scale 1:1



Corresponding cases

ET 150  
ET 154  
ET 156  
ET 157  
ET 160  
ET 169  
ET 171  
ET 190

see pages 71 - 73



6240

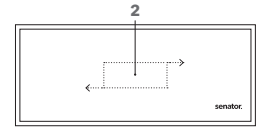
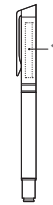

## ART. NO. 1037 / 6240

### Rollerball 1037

Metal in combination with light carbon  
Cap, tip, fittings: Metal, matt chrome  
Metal safety rollerball refill  
Ink colour: blue

### Set 6240

Twist ball pen 2159 + Rollerball 1037  
in black case ET 160

### SERVICES

Express Service (Online Portal): see page 102

## INDUSTRIAL PRICES (€/PC.)

RSP in euro, per piece, VAT not included.

	25	50	100	250
<b>1037</b>				
Plain	12.95	12.18	11.57	11.22
Incl. 1c standard print, 1 position	15.05	13.28	12.17	11.52
Incl. laser engraving, 1 position	15.45	13.68	12.57	11.92
<b>6240</b>	<b>10</b>	<b>25</b>	<b>50</b>	<b>100</b>
Plain	29.25	26.95	25.59	24.51
Incl. 1c standard print, 1 position	39.45	29.15	26.79	25.71
Incl. laser engraving, 1 position	40.25	29.95	27.59	26.51

## BRANDING / AREA

Cap	1	Standard print	30 x 12 mm 1 colour
		Laser engraving	40 x 5 mm
Case	2	Standard print	50 x 20 mm 1 colour

# CARBON LINE FOUNTAIN PEN

Image scale 1:1



Corresponding cases

ET 150  
ET 154  
ET 156  
ET 157  
ET 160  
ET 169  
ET 171  
ET 190

see pages 71 - 73



6239

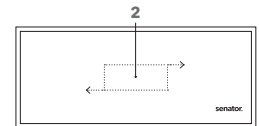

## ART. NO. 0076 / 6239

### Fountain pen 0076

Metal in combination with light carbon  
Cap, tip, fittings: Metal, matt chrome  
Iridium-tipped stainless steel nib, M  
Standard ink cartridge  
Ink colour: blue

### Set 6239

Twist ball pen 2159 + fountain pen 0076 in black  
case ET 160

### SERVICES

Express Service (Online Portal): see page 102

## INDUSTRIAL PRICES (€/PC.)

RSP in euro, per piece, VAT not included.

	25	50	100	250
<b>0076</b>				
Plain	13.95	13.12	12.46	12.09
Incl. 1c standard print, 1 position	16.05	14.22	13.06	12.39
Incl. laser engraving, 1 position	16.45	14.62	13.46	12.79
<b>6239</b>	<b>10</b>	<b>25</b>	<b>50</b>	<b>100</b>
Plain	30.35	27.95	26.53	25.40
Incl. 1c standard print, 1 position	40.55	30.15	27.73	26.60
Incl. laser engraving, 1 position	41.35	30.95	28.53	27.40

## BRANDING / AREA

Cap	1	Standard print	35 x 5 mm 1 colour
		Laser engraving	40 x 5 mm
Case	2	Standard print	50 x 20 mm 1 colour

**TIZIO**

## NATURALNESS WITH AN INDIVIDUAL TOUCH.

Natural writing with a special touch. For all those who appreciate the individual value of a natural material and write their messages with select care.



## TIZIO BALL PEN

Image scale 1:1



Laser engraving



Nutwood

Corresponding cases

- ET 150
- ET 157
- ET 160
- ET 169
- ET 171
- ET 181
- ET 190

see pages 71 - 73



6252  
6253

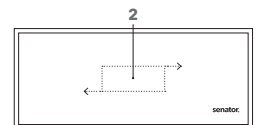
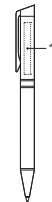

### ART. NO. 2400 / 6252 / 6253

#### Twist ball pen 2400

Barrel: Metal in combination with nutwood  
Cap, tip, fittings: Metal, glossy chrome  
senator® magic flow metal refill, G2  
Ink colour: blue

#### Set 6252

Twist ball pen 2400 + fountain pen 0240 in black case ET 160

#### Set 6253

Twist ball pen 2400 + rollerball 1240 in black case ET 160

#### SERVICES

Express Service (Online Portal): see page 102

### INDUSTRIAL PRICES (€/PC.)

RSP in euro, per piece, VAT not included.

	25	50	100	250
<b>2400</b>				
Plain	9.95	9.36	8.89	8.62
Incl. laser engraving, 1 position	12.45	10.86	9.89	9.32
<b>6252</b>	<b>10</b>	<b>25</b>	<b>50</b>	<b>100</b>
Plain	30.35	27.95	26.53	25.40
Incl. laser engraving, 1 position	41.35	30.95	28.53	27.40
<b>6253</b>	<b>10</b>	<b>25</b>	<b>50</b>	<b>100</b>
Plain	29.25	26.95	25.59	24.51
Incl. laser engraving, 1 position	40.25	29.95	27.59	26.51

### BRANDING / AREA

Cap	1	Laser engraving	40 x 5 mm
Case	2	Standard print	50 x 20 mm 1 colour

For branding prices please refer to page 113

# TIZIO ROLLERBALL

Image scale 1:1



Corresponding cases

ET 150  
ET 156  
ET 157  
ET 160  
ET 169  
ET 171  
ET 190

see pages 71 - 73



6253

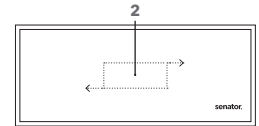
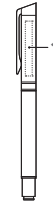

## ART. NO. 1240 / 6253

### Rollerball 1240

Barrel: Metal in combination with nutwood  
Cap, tip, fittings: Metal, glossy chrome  
Metal safety rollerball refill  
Ink colour: blue

### Set 6253

Twist ball pen 2400 + rollerball 1240 in black case  
ET 160

### SERVICES

**Express Service (Online Portal):** see page 102

## INDUSTRIAL PRICES (€/PC.)

RSP in euro, per piece, VAT not included.

	25	50	100	250
<b>1240</b>				
<b>Plain</b>	12.95	12.18	11.57	11.22
<b>Incl. laser engraving, 1 position</b>	15.45	13.68	12.57	11.92
<b>6253</b>				
<b>Plain</b>	29.25	26.95	25.59	24.51
<b>Incl. laser engraving, 1 position</b>	40.25	29.95	27.59	26.51

For branding prices please refer to page 113

## BRANDING / AREA

<b>Cap</b>	<b>1</b>	Laser engraving	40 x 5 mm
<b>Case</b>	<b>2</b>	Standard print	50 x 20 mm 1 colour

# TIZIO FOUNTAIN PEN

Image scale 1:1



Corresponding cases

ET 150  
ET 156  
ET 157  
ET 160  
ET 169  
ET 171  
ET 190

see pages 71 - 73



6252

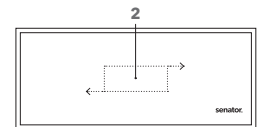

## ART. NO. 0240 / 6252

### Fountain pen 0240

Barrel: Metal in combination with nutwood  
Cap, fittings: Metal, glossy chrome  
Iridium-tipped stainless steel nib, M  
Standard ink cartridge  
Ink colour: blue

### Set 6252

Twist ball pen 2400 + fountain pen 0240 in black case ET 160

### SERVICES

**Express Service (Online Portal):** see page 102

## INDUSTRIAL PRICES (€/PC.)

RSP in euro, per piece, VAT not included.

	25	50	100	250
<b>0240</b>				
<b>Plain</b>	13.95	13.12	12.46	12.09
<b>Incl. laser engraving, 1 position</b>	16.45	14.62	13.46	12.79
<b>6252</b>				
<b>Plain</b>	30.35	27.95	26.53	25.40
<b>Incl. laser engraving, 1 position</b>	41.35	30.95	28.53	27.40

## BRANDING / AREA

<b>Cap</b>	<b>1</b>	Laser engraving	40 x 5 mm
<b>Case</b>	<b>2</b>	Standard print	50 x 20 mm 1 colour

# CASES

This list indicates which gift case fits which pen model. The crosses marked in grey are our recommendations.

	ET 150	ET 154	ET 156	ET 157	ET 160	ET 169	ET 171	ET 190	Box of 50
Arctic	×	×	×	×	×			×	
Arvent/Arvent Soft touch	×	×	×	×	×	×	×	×	
Attract/Attract Stylus	×	×	×	×	×	×	×	×	
Big Pen	×				×			×	×
Bridge	×	×	×	×	×	×	×	×	×
Carbon Black	×	×		×	×	×	×	×	
Carbon Line Twist ball pen	×	×		×	×	×	×	×	
Carbon Line Rollerball/Fountain pen	×	×	×	×	×	×	×	×	
Challenger	×	×		×	×	×	×	×	×
Challenger with soft grip	×	×		×	×	×		×	×
Dart	×	×	×	×	×	×	×	×	×
Delgado	×	×	×	×	×	×	×	×	
Duo Pen	×	×	×	×	×	×	×	×	×
Evoxx	×	×		×	×	×	×	×	×
Galant	×	×	×	×	×	×	×	×	
Hatrix with soft grip	×			×	×	×		×	×
Headliner	×	×	×	×	×	×	×	×	×
Image	×	×	×	×	×	×	×	×	
Liberty	×	×		×	×	×	×	×	×
Nature Plus	×	×		×	×	×	×	×	×
Nautic/Nautic Black	×	×	×	×	×	×	×	×	
New Spring	×	×		×	×	×	×	×	×
Phenix	×	×	×	×	×	×	×	×	×
Point	×	×	×	×	×	×	×	×	
Polar	×	×		×	×	×	×	×	
Signer Liner	×	×	×		×	×	×	×	
Skeye Bio	×	×	×	×	×	×	×	×	×
Soft Spring	×	×		×	×	×		×	×
Star Tec	×	×	×	×	×	×	×	×	
Super Hit	×	×		×	×	×	×	×	×
Super Hit with soft grip	×	×		×	×	×		×	×
Tizio Ball Pen	×			×	×	×	×	×	
Tizio Rollerball/Fountain pen	×		×	×	×	×		×	
Trento	×	×		×	×	×	×	×	×

# CASES

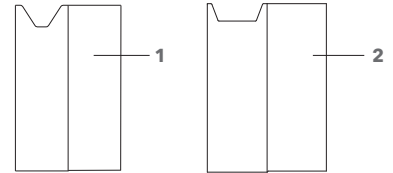

## ART. NO. P1ET157

### Cardboard pouch for 1 - 2 writing instruments

Matt white, front and back to be customised over the full surface area  
**Dimensions:** 155 x 48 x 2 cm

### BRANDING / AREA

Front + Reverse 1 ca. 155 x 96 mm

### INDUSTRIAL PRICES (€/PC.)

P1ET157	500	1,000	2,500	5,000	Filling in 1 pen	Filling in 2 pens
Incl. 4c print	1.90	1.22	0.80	0.63	0.20	0.30

## ART. NO. P1ET173

### Cardboard pouch for 3 writing instruments

Matt white, front and back to be customised over the full surface area  
**Dimensions:** 155 x 54 x 2 cm

### BRANDING / AREA

Front + Reverse 2 ca. 155 x 108 mm

### INDUSTRIAL PRICES (€/PC.)

P1ET173	500	1,000	2,500	5,000	Filling in 3 pens
Incl. 4c print	2.05	1.39	0.83	0.65	0.40



## ART. NO. ET 157

### For 1 writing instrument

Carton, matt black. At 5,000 pcs. also available in different colours  
**Dimensions:** 155 x 50 x 2 mm

### INDUSTRIAL PRICES (€/PC.)

ET157	500	1,000	2,500	5,000	Filling in 1 pen
Plain	0.23	0.23	0.23	0.23	0.20

## ART. NO. ET 190

### For 1 or 2 writing instruments

Carton, FSC Mix, matt black,  
 with removable cardboard insert  
**Dimensions:** 155 x 50 x 2 mm

### INDUSTRIAL PRICES (€/PC.)

ET190	50	100	250	500	Filling in 1 pen	Filling in 2 pens
Plain	1.89	1.89	1.89	1.89	0.20	0.30



# CASES

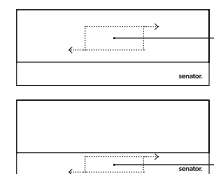

## ART. NO. ET 156

### Cardboard case for 1 or 2 writing instruments

carded case, black matt or glossy white with magnetic closure and foam inlay

**Dimensions:** 16,5 x 6,5 x 2,5 cm

### INDUSTRIAL PRICES (€/PC.)

ET156	25	50	100	250	Filling in 1 pen	Filling in 2 pens
Plain	1.59	1.59	1.59	1.59	0.20	0.30
Incl. 1c standard print, 1 position	3.69	2.69	2.19	1.89	0.20	0.30

### BRANDING / AREA

Lid	1	Standard print, 1 colour not on white	50 x 20 mm
	2	Standard print, 1 colour not on white	50 x 15 mm

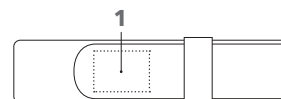
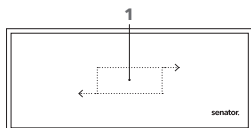

## ART. NO. ET 160

### For 1 or 2 writing instruments

leather look, black with black velour lining

**Dimensions:** 19 x 8 x 3,5 cm

### BRANDING / AREA

Lid	1	Standard print, 1 colour	50 x 20 mm
-----	---	--------------------------	------------

### INDUSTRIAL PRICES (€/PC.)

ET160	25	50	100	250	Filling in 1 pen	Filling in 2 pens
Plain	3.75	3.75	3.75	3.75	0.20	0.30
Incl. 1c standard print, 1 position	5.85	4.85	4.35	4.05	0.20	0.30

## ART. NO. ET 150

### Leather case for 1 or 2 writing instruments

leather, black

**Dimensions:** 15 x 3,5 x 1,5 cm

### BRANDING / AREA

Lasche	1	Embossing	30 x 22 mm
--------	---	-----------	------------

### INDUSTRIAL PRICES (€/PC.)

ET150	25	50	100	250	Filling in 1 pen	Filling in 2 pens
Plain	3.80	3.80	3.80	3.80	0.20	0.30
Incl. embossing, incl. stamp	11.00	8.00	6.50	5.60	0.20	0.30

# CASES

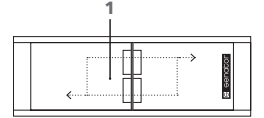
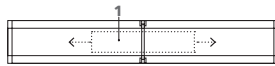
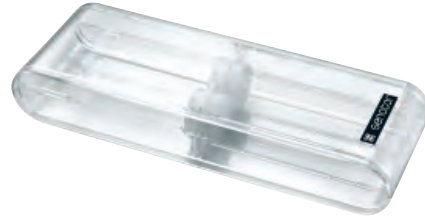

## ART. NO. ET 169

**Plastic case for 1 writing instrument**  
Glossy transparent with universal pen holder  
**Dimensions:** 15,5 x 2,5 x 2,5 cm

### BRANDING / AREA

**Lid** 1 Standard print, 1 colour 60 x 12 mm

### INDUSTRIAL PRICES (€/PC.)

ET169	25	50	100	250	Filling in 1 pen
Plain	0.49	0.49	0.49	0.49	0.20
Incl. 1c standard print, 1 position	2.59	1.59	1.09	0.79	0.20

## ART. NO. ET 171

**Plastic case for 2 writing instruments**  
Glossy transparent with universal pen holder  
**Dimensions:** 15,5 x 5,5 x 2,5 cm

### BRANDING / AREA

**Lid** 1 Standard print, 1 colour 60 x 25 mm

### INDUSTRIAL PRICES (€/PC.)

ET171	50	100	250	500	Filling in 2 pens
Plain	0.81	0.81	0.81	0.81	0.30
Incl. 1c standard print, 1 position	1.91	1.41	1.11	1.01	0.30

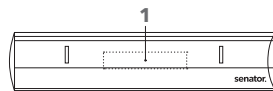

## ART. NO. ET 154

**Plastic case for 1 writing instrument**  
black/silver with transparent lid, also available for slim writing instruments  
**Dimensions:** 16 x 3,5 x 2,5 cm

### BRANDING / AREA

**Lid** 1 Standard print, 1 colour 50 x 10 mm

### INDUSTRIAL PRICES (€/PC.)

ET154	25	50	100	250	Filling in 1 pen
Plain	0.81	0.81	0.81	0.81	0.20
Incl. 1c standard print, 1 position	2.91	1.91	1.41	1.11	0.20

## ART. NO. SC 233

**Cardboard box for 50 pens**  
Alternative packaging for your pens:  
Carton: white, with senator® logo  
**Dimensions:** 15,5 x 12 x 7,5 cm

### INDUSTRIEPREISE (€/ST.)

SC233	25	50	100	250
Plain	0.70	0.70	0.70	0.70

## NOTE STRUCTURE

# SIMPLY CLEVERLY STRUCTURED.

The senator® notebooks are practical companions in everyday life. With a clever insertion flap for a writing instrument and a rubber band for closing, the Notebook Structure with a pleasant surface keeps all notes firmly in hand.



## NOTEBOOK STRUCTURE

Image scale 1:4

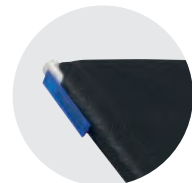

With clever pen pocket

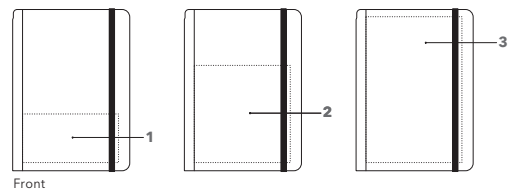

### ART. NO. NB01

#### Black hardcover notebook

with textured surface and clever pen insert. Elastic band for closing. With black bookmark. 80 sheets of paper, 100 g/m<sup>2</sup>, white, perforated.

#### Ruling:

Blank

Dimensions: ~ DIN A5

### INDUSTRIAL PRICES (€/PC.)

RSP in euro, per piece, VAT not included.

NB01	25	50	100	250
Plain	5.01	4.91	4.84	4.79
Digital print 1/3 area	8.61	7.71	7.24	6.95
Digital print 2/3 area	10.61	9.71	9.24	8.95
Digital print 3/3 area	12.61	11.71	11.24	10.95

For branding prices please refer to page 113

### BRANDING / AREA

Front		
1	Digital print 1/3 area	125 x 63.3 mm
2	Digital print 2/3 area	125 x 126.6 mm
3	Digital print 3/3 area	125 x 190 mm

## NOTE STRUCTURE MAGNET

### FUNCTIONAL EYE-CATCHER.

The senator® notebooks are practical companions in daily life. The elegant notebook is a small office for on the go. With stylish magnetic closure that also holds a writing instrument.



## NOTEBOOK STRUCTURE MAGNET

Image scale 1:4



With clever pen pocket

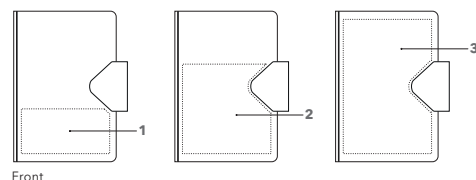

#### ART. NO. NB02

##### Black hardcover notebook

with textured surface and high-quality magnetic closure, which also serves as a pen holder.

With black bookmark.

80 sheets of paper, 100 g/m<sup>2</sup>, white, perforated.

##### Ruling:

Blank

Dimensions: ~ DIN A5

#### INDUSTRIAL PRICES (€/PC.)

RSP in euro, per piece, VAT not included.

NB02	25	50	100	250
Plain	5.11	5.01	4.94	4.89
Digital print 1/3 area	8.71	7.81	7.34	7.05
Digital print 2/3 area	10.71	9.81	9.34	9.05
Digital print 3/3 area	12.71	11.81	11.34	11.05

For branding prices please refer to page 113

#### BRANDING / AREA

Front	1	2	3
Digital print 1/3 area	125 x 63.3 mm		
Digital print 2/3 area		125 x 126.6 mm	
Digital print 3/3 area			125 x 190 mm

# NOTEBOOK SOFT



Image scale 1:4

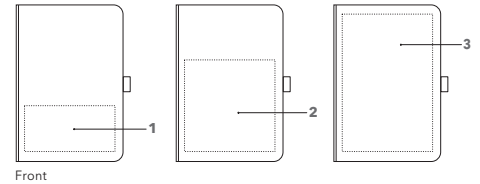
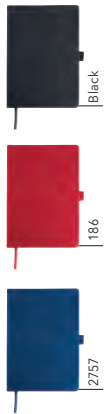

## ART. NO. NB03

### Hardcover notebook

with pleasant soft surface.  
With coloured bookmark.  
Perfect in combination with holder NB04.  
96 sheets of paper, 80 g/m<sup>2</sup>, white

### Ruling:

Blank

**Dimensions:** ~ DIN A5

## INDUSTRIAL PRICES (€/PC.)

RSP in euro, per piece, VAT not included.

NB03	25	50	100	250
<b>Plain</b>	3.88	3.81	3.75	3.71
<b>Digital print 1/3 area</b>	7.48	6.61	6.15	5.87
<b>Digital print 2/3 area</b>	9.48	8.61	8.15	7.87
<b>Digital print 3/3 area</b>	11.48	10.61	10.15	9.87

For branding prices please refer to page 113

## BRANDING / AREA

Front		
<b>1</b>	Digital print 1/3 area	125 x 63.3 mm
<b>2</b>	Digital print 2/3 area	125 x 126.6 mm
<b>3</b>	Digital print 3/3 area	125 x 190 mm

# HOLDER SOFT

Image scale 1:4

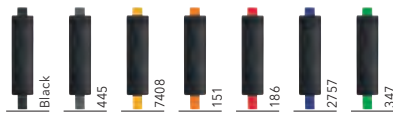

Suitable for notebook NB03

## ART. NO. NB04

### Pen holder for notebook NB03

Gives the notebook an individual adjustment to the color of the brand. Available with elastic band in 7 different colours.

**Dimensions holder:** 4,5 x 16,2 cm

## INDUSTRIAL PRICES (€/PC.)

RSP in euro, per piece, VAT not included.

NB04	25	50	100	250
<b>Plain</b>	0.85	0.85	0.85	0.85

# NOTEBOOK PAPER

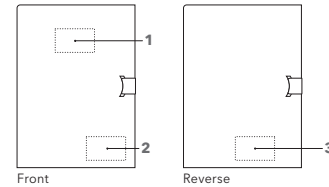

## ART. NO. NB05

### Notebook made of FSC paper

Clever pen pocket with plastic-free tab.  
Perfect in combination with our ball pens made of bio-based material.  
96 sheets of paper, 80 g/m<sup>2</sup>, white

#### Ruling:

Blank

Dimensions: ~ DIN A5

## INDUSTRIAL PRICES (€/PC.)

RSP in euro, per piece, VAT not included.

NB05	25	50	100	250
Plain	1.83	1.80	1.77	1.75
Incl. 1c standard print, 1 position	3.93	2.90	2.37	2.05

## BRANDING / AREA

Front	1	Standard print, 1 colour	50 x 30 mm
	2	Standard print, 1 colour	50 x 30 mm
Reverse	3	Standard print, 1 colour	50 x 30 mm

For branding prices please refer to page 113

# NOTEBOOK PAPER, SMALL

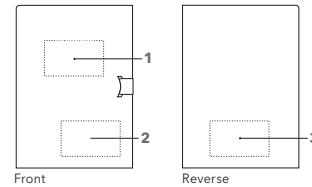

## ART. NO. NB06

### Small notebook made of FSC paper

Clever pen pocket with plastic-free tab.  
Perfect in combination with our ball pens made of bio-based material.  
96 sheets of paper, 80 g/m<sup>2</sup>, white

#### Ruling:

Blank

Dimensions: ~ DIN A6

## INDUSTRIAL PRICES (€/PC.)

RSP in euro, per piece, VAT not included.

NB06	25	50	100	250
Plain	1.83	1.80	1.77	1.75
Incl. 1c standard print, 1 position	3.93	2.90	2.37	2.05

## BRANDING / AREA

Front	1	Standard print, 1 colour	50 x 30 mm
	2	Standard print, 1 colour	50 x 30 mm
Reverse	3	Standard print, 1 colour	50 x 30 mm

For branding prices please refer to page 113

## KING CAN

### LOOKS COOL. KEEPS HOT.

senator® King Can "To Go" mugs are the perfect every day companions. These vacuum thermo mugs keep hot drinks hot and cold drinks cold. Useful, long lasting and so popular.



## KING CAN

Image scale 1:2



Art. 0765



#### ART. NO. 0755 / 0765

##### Vacuum thermo mug

double-walled 18/8 stainless steel, with black plastic lid

**0755:** King Can

**0765:** King Can for sublimation

**Height:** ~ 149 mm

**Diameter:** ~ 71 mm

**Capacity:** ~ 0.33 l

##### SERVICES

Individually packed in cardboard box

**Express Service (Online Portal):**

see page 102

#### INDUSTRIAL PRICES (€/PC.)

RSP in euro, per piece, VAT not included.

0755	72	108	250	500
<b>Plain</b>	7.45	7.35	7.15	6.74
<b>Incl. 1c Direct print, 1 position</b>	9.45	8.85	8.35	7.84
Each further print colour	2.00	1.50	1.20	1.10
<b>Incl. Engraving, 1 position</b>	10.45	9.85	9.35	8.84
<b>Incl. 1c Transfer print, 1 position</b>	9.95	9.35	8.85	8.34
Each further print colour per position	1.50	1.00	0.70	0.60
<b>0765</b>	<b>36</b>	<b>72</b>	<b>108</b>	<b>250</b>
<b>Incl. Sublimation</b>	11.55	10.45	9.85	9.35

For branding prices please refer to page 113

#### BRANDING / AREA

Outside		
<b>1</b>	Direct print up to 3 colours	170 x 80 mm
	Sublimation (White prints will show silver coloured)	150 x 80 mm
<b>2</b>	Transfer print	210 x 115 mm
<b>3</b>	Laser engraving	12 cm <sup>2</sup>
		(e. g. 20 x 60 mm)

# KING CAN MINI

Image scale 1:2



Direct print

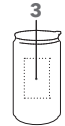
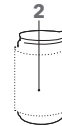
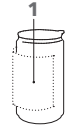

## ART. NO. 0785

**Vacuum thermo mug**  
double-walled 18/8 stainless steel, with black plastic lid

**Height:** ~ 127 mm  
**Diameter:** ~ 71 mm  
**Capacity:** ~ 0.26 l

### SERVICES

Individually packed in cardboard box.

## INDUSTRIAL PRICES (€/PC.)

RSP in euro, per piece, VAT not included.

0785	72	108	250	500
<b>Plain</b>	7.25	7.15	6.95	6.54
<b>Incl. 1c Direct print, 1 position</b>	9.25	8.65	8.15	7.64
Each further print colour	2.00	1.50	1.20	1.10
<b>Incl. Engraving, 1 position</b>	10.25	9.65	9.15	8.64
<b>Incl. 1c Transfer print, 1 position</b>	9.75	9.15	8.65	8.14
Each further print colour per position	1.50	1.00	0.70	0.60

For branding prices please refer to page 113

## BRANDING / AREA

Outside		
<b>1</b>	Direct print up to 3 colours	170 x 70 mm
<b>2</b>	Transfer print	210 x 90 mm
<b>3</b>	Laser engraving	12 cm <sup>2</sup> (e. g. 20 x 60 mm)

# TROPHY

Image scale 1:2



Transfer print

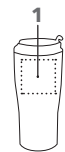

## ART. NO. 0750

**Large vacuum thermo mug**  
double-walled 18/8 stainless steel, with black plastic lid

**Height:** ~ 175 mm  
**Diameter:** ~ 82 mm  
**Capacity:** ~ 0.4 l

### SERVICES

Individually packed in cardboard box.

**Express Service (Online Portal):**  
see page 102

## INDUSTRIAL PRICES (€/PC.)

RSP in euro, per piece, VAT not included.

0750	72	108	250	500
<b>Plain</b>	7.45	7.35	7.15	6.74
<b>Incl. 1c Direct print, 1 position</b>	9.45	8.85	8.35	7.84
Each further print colour	2.00	1.50	1.20	1.10
<b>Incl. Engraving, 1 position</b>	10.45	9.85	9.35	8.84
<b>Incl. 1c Transfer print, 1 position</b>	9.95	9.35	8.85	8.34
Each further print colour per position	1.50	1.00	0.70	0.60

For branding prices please refer to page 113

## BRANDING / AREA

Outside		
<b>1</b>	Transfer print Laser engraving	60 x 60 mm 12 cm <sup>2</sup> (e. g. 20 x 60 mm)
<b>2</b>	Transfer print	150 x 30 mm
<b>3</b>	Direct print up to 3 colours	50 x 20 mm



## OUTDOOR

# LONG-LASTING COMPANION IN CHARMING VINTAGE STYLE.

Simply unbeatable in durability and charm. Classic design, unbreakable and weatherproof. A companion for carefree outdoor leisure activities.



## OUTDOOR

Image scale 1:2



Art. 0372

Sublimation  
print



Direct print

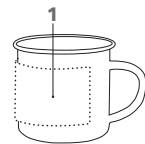

### ART. NO. 0373 / 0372

**Metal cup**  
with enamel coating, high-gloss white

**0373:** Outdoor

**0372:** Outdoor for sublimation

**Height:** ~81 mm

**Diameter:** ~87 mm

**Capacity:** ~0.3 l

### INDUSTRIAL PRICES (€/PC.)

RSP in euro, per piece. VAT not included.

	72	108	250	500
<b>0373</b>				
<b>Plain</b>	4.89	4.79	4.65	4.38
<b>Incl. 1c Direct print. 1 position</b>	6.89	6.29	5.85	5.48
Each further print colour	2.00	1.50	1.20	1.10
<b>0372</b>	<b>36</b>	<b>72</b>	<b>108</b>	<b>250</b>
<b>Incl. Sublimation</b>	8.99	7.89	7.29	6.85

For branding prices please refer to page 113

### BRANDING / AREA

Outside	1	Direct print up to 4 colours	170 x 55 mm
		Sublimation	185 x 60 mm

## ELEGANT

### MODERN DESIGN WITH SOFT CONTOURS.

Beautiful, modern shape, large volume, pleasant weight and great advertising space: The Elegant combines everything that a modern promotional mug must be able to do.

## ELEGANT

Image scale 1:2

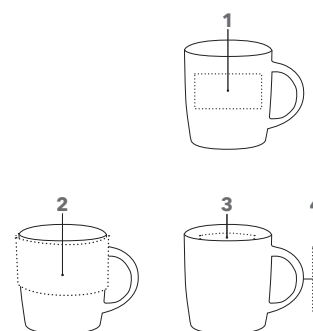

#### ART. NO. 0381

##### Porcelain mug

Slightly conical shape, high gloss white

**Height:** ~92 mm

**Diameter:** ~86 mm

**Capacity:** ~0.3 l

##### SERVICES

**PMS Service (Colour 4U):** see page 100

**Packaging:** see pages 98 - 99

#### INDUSTRIAL PRICES (€/PC.)

RSP in euro, per piece, VAT not included.

0381	108	250	500	1,000
<b>Plain</b>	2.20	2.14	2.03	1.97
<b>Incl. 1c Direct print, 1 position</b>	3.70	3.34	3.13	3.02
Each further print colour	1.50	1.20	1.10	1.05
<b>Incl. 1c Transfer print, 1 position</b>	4.20	3.84	3.63	3.52
Each further print colour per position	1.00	0.70	0.60	0.55

For branding prices please refer to page 113

\* Elegant 0381: Will be made in Germany from July 1, 2021.  
Surcharge: 0.30 €/pc.

#### BRANDING / AREA

Outside	1	Direct print up to 4 colours	190 x 40 mm
	2	Transfer print	240 x 50 mm
Inside	4	Transfer print	50 x 15 mm
Handle	5	Transfer print	70 x 8 mm

## ELITE INSIDE

# A BRILLIANT APPEARANCE – BOTH OUTSIDE AND INSIDE.

Do you want to really shine? Then the Elite is the perfect choice. The top seller with format, in a timelessly elegant shape and with coloured inside - a model that inspires.



## ELITE INSIDE

Image scale 1:2

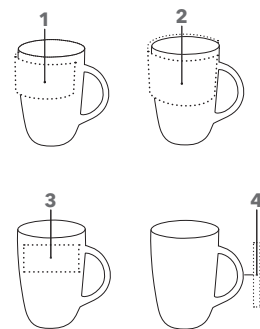

### ART. NO. 0353 / 0355

#### Stoneware mug

in favoured design, high-gloss white with coloured interior glaze

**0353:** Elite Inside

**0355:** Elite Inside for sublimation

**Height:** ~ 99 mm

**Diameter:** ~ 82 mm

**Capacity:** ~ 0.25 l

#### SERVICES

**Packaging:** see pages 98 - 99

### INDUSTRIAL PRICES (€/PC.)

RSP in euro, per piece, VAT not included.

<b>0353</b>	<b>108</b>	<b>250</b>	<b>500</b>	<b>1,000</b>
<b>Plain</b>	2.60	2.54	2.43	2.17
<b>Incl. 1c Direct print, 1 position</b>	4.10	3.74	3.53	3.22
Each further print colour	1.50	1.20	1.10	1.05
<b>Incl. Engraving, 1 position</b>	5.10	4.74	4.53	4.22
<b>Incl. 1c Transfer print, 1 position</b>	4.60	4.24	4.03	3.72
Each further print colour per position	1.00	0.70	0.60	0.55
<b>0355</b>	<b>36</b>	<b>72</b>	<b>108</b>	<b>250</b>
<b>Incl. Sublimation</b>	6.80	5.70	5.10	4.74

For branding prices please refer to page 113

### BRANDING / AREA

Outside		
<b>1</b>	Direct print up to 4 colours	175 x 35 mm
	Sublimation	180 x 35 mm
	Transfer print	215 x 50 mm
<b>3</b>	Engraving	60 x 30 mm

Handle		
<b>4</b>	Transfer print	70 x 7 mm

\* Elite Inside 0353: Will be made in Germany from July 1, 2021. Surcharge: 0.30 €/pc.

# ELITE

Image scale 1:2

Sublimation

Direct print



White



Art. 0354

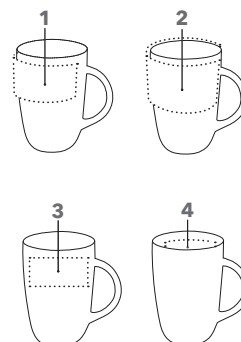

## ART. NO. 0912 / 0354

### Tapered mug

in favoured design, high-gloss white

**0912:** Elite, porcelain\*

**0354:** Elite for sublimation, stoneware

**Height:** ~99 mm

**Diameter:** ~82 mm

**Capacity:** ~0.25 l

### SERVICES

**PMS Service (Colour 4U):** see page 100

**Packaging:** see pages 98 - 99

## INDUSTRIAL PRICES (€/PC.)

RSP in euro, per piece, VAT not included.

	108	250	500	1,000
<b>0912</b>				
<b>Plain</b>	2.10	2.04	1.93	1.87
<b>Incl. 1c Direct print, 1 position</b>	3.60	3.24	3.03	2.92
Each further print colour	1.50	1.20	1.10	1.05
<b>Incl. Engraving, 1 position</b>	4.60	4.24	4.03	3.92
<b>Incl. 1c Transfer print, 1 position</b>	4.10	3.74	3.53	3.42
Each further print colour per position	1.00	0.70	0.60	0.55
<b>0354</b>	<b>36</b>	<b>72</b>	<b>108</b>	<b>250</b>
<b>Incl. Sublimation</b>	6.30	5.20	4.60	4.24

For branding prices please refer to page 113

## BRANDING / AREA

<b>Outside</b>	<b>1</b> Direct print up to 4 colours	175 x 35 mm
	Sublimation	180 x 35 mm
	<b>2</b> Transfer print	215 x 50 mm
<b>Inside</b>	<b>3</b> Engraving	60 x 30 mm
	<b>4</b> Transfer print	50 x 20 mm
<b>Handle</b>	<b>5</b> Transfer print	70 x 7 mm

\* Elite 0912: Will be made in Germany from July 1, 2021. Surcharge: 0.30 €/pc.

# ELITE MATT

Image scale 1:2

Laser engraving

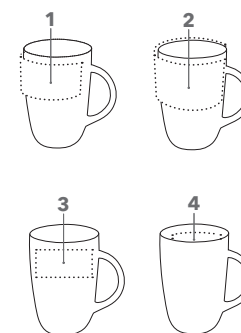

PMS 426U



PMS 540U



HKS 14

## ART. NO. 0343

### Stoneware mug

in modern design, matt colours

**Height:** ~99 mm

**Diameter:** ~82 mm

**Capacity:** ~0.25 l

### SERVICES

**Packaging:** see pages 98 - 99

## INDUSTRIAL PRICES (€/PC.)

RSP in euro, per piece, VAT not included.

	108	250	500	1,000
<b>0343</b>				
<b>Plain</b>	3.10	3.04	2.93	2.87
<b>Incl. 1c Direct print, 1 position</b>	4.60	4.24	4.03	3.92
Each further print colour	1.50	1.20	1.10	1.05
<b>Incl. Engraving, 1 position</b>	5.60	5.24	5.03	4.92
<b>Incl. 1c Transfer print, 1 position</b>	5.10	4.74	4.53	4.42
Each further print colour per position	1.00	0.70	0.60	0.55

For branding prices please refer to page 113

\* Elite 0343: Will be made in Germany from July 1, 2021. Surcharge: 0.30 €/pc.

## BRANDING / AREA

<b>Outside</b>	<b>1</b> Direct print up to 3 colours	175 x 35 mm
	<b>2</b> Transfer print	215 x 50 mm
	<b>3</b> Laser engraving	12 cm <sup>2</sup> (60 x 20 mm or 40 x 30 mm)
<b>Inside</b>	<b>4</b> Transfer print	50 x 20 mm
<b>Handle</b>	<b>5</b> Transfer print	70 x 7 mm

## AMITY

### SMALL SIZE – GREAT DESIGN.

A designer piece with a strong characteristic handle. With its size, it fits under all commercially available coffee pod machines and at the same time stands its ground with its large print areas.



## AMITY

Image scale 1:2



Transfer print

Transfer print

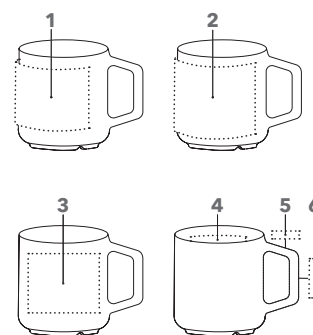

#### ART. NO. 0321

##### Small porcelain mug

glossy white, suitable for coffee pod machines

Height: ~ 85 mm

Diameter: ~ 80 mm

Capacity: ~ 0.25 l

##### SERVICES

PMS Service (Colour 4U): see page 100

Packaging: see pages 98 - 99

#### INDUSTRIAL PRICES (€/PC.)

RSP in euro, per piece, VAT not included.

0321	108	250	500	1,000
Plain	2.00	1.95	1.84	1.79
Incl. 1c Direct print, 1 position	3.50	3.15	2.94	2.84
Each further print colour	1.50	1.20	1.10	1.05
Incl. Engraving, 1 position	4.50	4.15	3.94	3.84
Incl. 1c Transfer print, 1 position	4.00	3.65	3.44	3.34
Each further print colour per position	1.00	0.70	0.60	0.55

For branding prices please refer to page 113

Amity 0321: Will be made in Germany from July 1, 2021.  
Surcharge: 0.30 €/pc.

#### BRANDING / AREA

Outside	1	Direct print up to 4 colours	170 x 55 mm
	2	Transfer print	220 x 70 mm
	3	Engraving	60 x 50 mm
Inside	4	Transfer print	50 x 20 mm
Handle	5	Transfer print	20 x 8 mm
	6	Transfer print	40 x 8 mm

**MAXIM****UNUSUAL SHAPE -  
MAXIMUM ATTENTION.**

The perfect combination of round shape and angular profile edges. An eye-catcher in an unusual form with high popularity.

**MAXIM**

Image scale 1:2



Transfer print

Transfer print

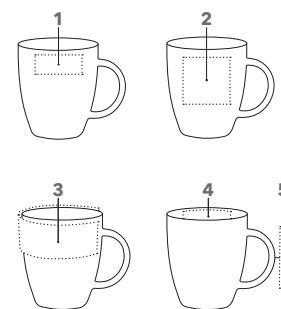
**ART. NO. 0914**

**Porcelain mug**  
with unusual shape, high-gloss white  
For further Maxim products see  
pages 95 - 97

**Height:** ~99 mm  
**Diameter:** ~86 mm  
**Capacity:** ~0.3 l

**SERVICES**

**PMS Service (Colour 4U):** see page 100  
**Packaging:** see pages 98 - 99

**INDUSTRIAL PRICES (€/PC.)**

RSP in euro, per piece, VAT not included.

<b>0914</b>	<b>108</b>	<b>250</b>	<b>500</b>	<b>1,000</b>
<b>Plain</b>	2.38	2.32	2.19	2.13
<b>Incl. 1c Direct print, 1 position</b>	3.88	3.52	3.29	3.18
Each further print colour	1.50	1.20	1.10	1.05
<b>Incl. Engraving, 1 position</b>	4.88	4.52	4.29	4.18
<b>Incl. 1c Transfer print, 1 position</b>	4.38	4.02	3.79	3.68
Each further print colour per position	1.00	0.70	0.60	0.55

For branding prices please refer to page 113

**BRANDING / AREA**

<b>Outside</b>	<b>1</b>	Direct print up to 2 colours	50 x 20 mm
		Engraving	50 x 30 mm
	<b>2</b>	Transfer print	50 x 50 mm
	<b>3</b>	Transfer print	225 x 35 mm
<b>Inside</b>	<b>4</b>	Transfer print	50 x 20 mm
<b>Handle</b>	<b>5</b>	Transfer print	70 x 7 mm

# PICS SOLID

Image scale 1:2



Sublimation

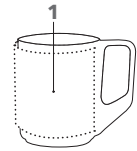

## ART. NO. 0358

**Stoneware mug**  
with unique handle, high-gloss white  
**Height:** ~ 99 mm  
**Diameter:** ~ 80 mm  
**Capacity:** ~ 0.25 l

## INDUSTRIAL PRICES (€/PC.)

RSP in euro, per piece, VAT not included.

0358	36	72	108	250
<b>Incl. Sublimation</b>	6.40	5.30	4.70	4.34

For branding prices please refer to page 113

## BRANDING / AREA

Outside	1	Sublimation	180 x 80 mm
---------	---	-------------	-------------

## SERVICES

**Packaging:** see pages 98 - 99

# COSMOS

Image scale 1:2



Sublimation

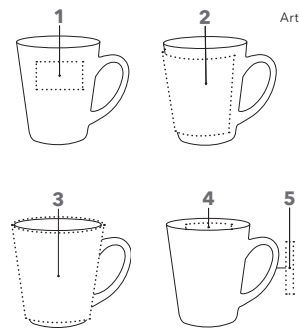

## ART. NO. 0926 / 0356

**Large mug**  
in modern, conical shape, high-gloss white  
**0926:** Cosmos, porcelain\*  
**0356:** Cosmos for sublimation, porcelain

**Height:** ~ 107 mm  
**Diameter:** ~ 95 mm  
**Capacity:** ~ 0.33 l

## INDUSTRIAL PRICES (€/PC.)

RSP in euro, per piece, VAT not included.

0926	108	250	500	1,000
<b>Plain</b>	3.12	3.03	2.86	2.77
<b>Incl. 1c Direct print, 1 position</b>	4.62	4.23	3.96	3.82
Each further print colour	1.50	1.20	1.10	1.05
<b>Incl. Engraving, 1 position</b>	5.62	5.23	4.96	4.82
<b>Incl. 1c Transfer print, 1 position</b>	5.12	4.73	4.46	4.32
Each further print colour per position	1.00	0.70	0.60	0.55
<b>0356</b>	<b>36</b>	<b>72</b>	<b>108</b>	<b>250</b>
<b>Incl. Sublimation</b>	7.32	6.22	5.62	5.23

For branding prices please refer to page 113

## BRANDING / AREA

Outside	1	Direct print, 1 colour	50 x 30 mm
		Engraving	60 x 40 mm
	2	Sublimation	190 x 80 mm
	3	Transfer print	270 x 103 mm
Inside	4	Transfer print	50 x 20 mm
Handle	5	Transfer print	60 x 8 mm

Cosmos 0926: Will be made in Germany from July 1, 2021.  
Surcharge: 0.30 €/pc.

# CHARISMA

Image scale 1:2



INTRODUCTION

PLASTIC PENS

## ART. NO. 0915

### High porcelain mug

with small handle, high-gloss white

Height: ~ 100 mm

Diameter: ~ 82 mm

Capacity: ~ 0.25 l

### SERVICES

PMS Service (Colour 4U): see page 100

Packaging: see pages 98 - 99

## INDUSTRIAL PRICES (€/PC.)

RSP in euro, per piece, VAT not included.

0915	108	250	500	1,000
Plain	2.31	2.25	2.11	2.05
Incl. 1c Direct print, 1 position	3.81	3.45	3.21	3.10
Each further print colour	1.50	1.20	1.10	1.05
Incl. Engraving, 1 position	4.81	4.45	4.21	4.10
Incl. 1c Transfer print, 1 position	4.31	3.95	3.71	3.60
Each further print colour per position	1.00	0.70	0.60	0.55

For branding prices please refer to page 113

Appeal 0928: Will be made in Germany from July 1, 2021.  
Surcharge: 0.30 €/pc.

## BRANDING / AREA

Outside	1	Direct print, 1 colour	50 x 35 mm
		Engraving	60 x 30 mm
	2	Transfer print	233 x 96 mm
Inside	3	Transfer print	50 x 20 mm
Handle	4	Transfer print	50 x 12 mm

METAL PENS

# APPEAL

Image scale 1:2



NOTEBOOKS

## ART. NO. 0928

### Large porcelain mug

in rounded shape, high-gloss white

Height: ~ 94 mm

Diameter: ~ 99 mm

Capacity: ~ 0.4 l

### SERVICES

PMS Service (Colour 4U): see page 100

Packaging: see pages 98 - 99

## INDUSTRIAL PRICES (€/PC.)

RSP in euro, per piece, VAT not included.

0928	108	250	500	1,000
Plain	3.12	3.03	2.86	2.77
Incl. 1c Direct print, 1 position	4.62	4.23	3.96	3.82
Each further print colour	1.50	1.20	1.10	1.05
Incl. Engraving, 1 position	5.62	5.23	4.96	4.82
Incl. 1c Transfer print, 1 position	5.12	4.73	4.46	4.32
Each further print colour per position	1.00	0.70	0.60	0.55

For branding prices please refer to page 113

Appeal 0928: Will be made in Germany from July 1, 2021.  
Surcharge: 0.30 €/pc.

## BRANDING / AREA

Outside	1	Direct print, 1 colour	50 x 45 mm
		Engraving	60 x 40 mm
	2	Transfer print	270 x 45 mm
Inside	3	Transfer print	50 x 20 mm
Handle	4	Transfer print	50 x 5 mm

MUGS

SERVICES



# PICS ONE

Image scale 1:2



## ART. NO. 0323

### Stoneware mug

in straight design, high-gloss white

**Height:** ~96 mm  
**Diameter:** ~82 mm  
**Capacity:** ~0.3 l

### SERVICES

**Packaging:** see pages 98 - 99

## INDUSTRIAL PRICES (€/PC.)

RSP in euro, per piece, VAT not included.

0323	36	72	108	250
<b>Incl. Sublimation</b>	6.00	4.90	4.30	3.95

For branding prices please refer to page 113

## BRANDING / AREA

Outside	1	Sublimation	205 x 80 mm
---------	---	-------------	-------------

# MAXI MUG

Image scale 1:2



## ART. NO. 0344

### Large porcelain mug

in classic design, high-gloss white

**Height:** ~95.5 mm  
**Diameter:** ~81.5 mm  
**Capacity:** ~0.3 l

### SERVICES

**PMS Service (Colour 4U):** see page 100

**Packaging:** see pages 98 - 99

## INDUSTRIAL PRICES (€/PC.)

RSP in euro, per piece, VAT not included.

0344	108	250	500	1,000
<b>Plain</b>	2.21	2.15	2.03	1.97
<b>Incl. 1c Direct print, 1 position</b>	3.71	3.35	3.13	3.02
Each further print colour	1.50	1.20	1.10	1.05
<b>Incl. Engraving, 1 position</b>	4.71	4.35	4.13	4.02
<b>Incl. 1c Transfer print, 1 position</b>	4.21	3.85	3.63	3.52
Each further print colour per position	1.00	0.70	0.60	0.55

For branding prices please refer to page 113

Maxi Mug 0344 : Will be made in Germany from July 1, 2021.  
Surcharge: 0.30 €/pc.

## BRANDING / AREA

Outside	1	Direct print up to 4 colours	180 x 70 mm
	2	Transfer print	253 x 89 mm
	3	Engraving	60 x 60 mm
Inside	4	Transfer print	50 x 20 mm
Handle	5	Transfer print	45 x 6 mm

# PICS MINI

Image scale 1:2

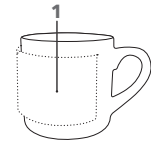
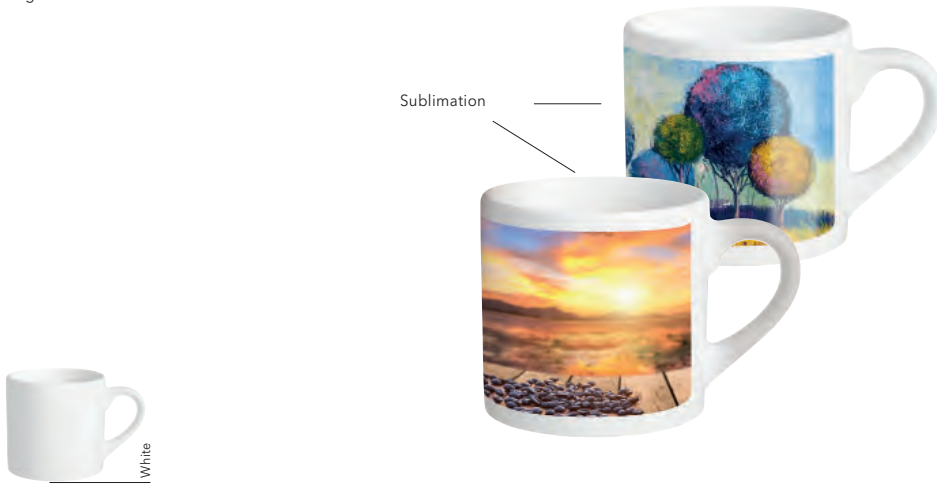

INTRODUCTION

PLASTIC PENS

## ART. NO. 0371

**Small stoneware mug**  
glossy white,  
suitable for coffee pod machines

**Height:** ~ 69 mm  
**Diameter:** ~ 72 mm  
**Capacity:** ~ 0.15 l

### SERVICES

**Packaging:** see pages 98 - 99

## INDUSTRIAL PRICES (€/PC.)

RSP in euro, per piece, VAT not included.

<b>0371</b>	<b>36</b>	<b>72</b>	<b>108</b>	<b>250</b>
<b>Incl. Sublimation</b>	5.95	4.85	4.25	3.90

For branding prices please refer to page 113

## BRANDING / AREA

<b>Outside</b>	<b>1</b>	Sublimation	165 x 58 mm
----------------	----------	-------------	-------------

# PICS TWO

Image scale 1:2

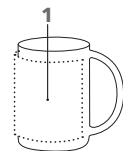

METAL PENS

NOTEBOOKS

## ART. NO. 0324

**Slim stoneware mug**  
in minimalist design, high-gloss white

**Height:** ~ 105 mm  
**Diameter:** ~ 76 mm  
**Capacity:** ~ 0.3 l

### SERVICES

**Packaging:** see pages 98 - 99

## INDUSTRIAL PRICES (€/PC.)

RSP in euro, per piece, VAT not included.

<b>0324</b>	<b>36</b>	<b>72</b>	<b>108</b>	<b>250</b>
<b>Incl. Sublimation</b>	6.00	4.90	4.30	3.95

For branding prices please refer to page 113

## BRANDING / AREA

<b>Outside</b>	<b>1</b>	Sublimation	200 x 85 mm
----------------	----------	-------------	-------------

MUGS

SERVICES

# CULT

Image scale 1:2

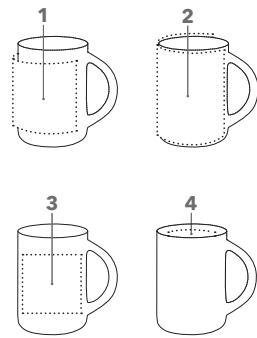

## ART. NO. 0911

**Slim porcelain mug**  
in linear design, high-gloss white  
**Height:** ~ 104 mm  
**Diameter:** ~ 75 mm  
**Capacity:** ~ 0.25 l

### SERVICES

**PMS Service (Colour 4U):** see page 100  
**Packaging:** see pages 98 - 99

## INDUSTRIAL PRICES (€/PC.)

RSP in euro, per piece, VAT not included.

0911	108	250	500	1,000
<b>Plain</b>	1.90	1.85	1.75	1.70
<b>Incl. 1c Direct print, 1 position</b>	3.40	3.05	2.85	2.75
Each further print colour	1.50	1.20	1.10	1.05
<b>Incl. Engraving, 1 position</b>	4.40	4.05	3.85	3.75
<b>Incl. 1c Transfer print, 1 position</b>	3.90	3.55	3.35	3.25
Each further print colour per position	1.00	0.70	0.60	0.55

For branding prices please refer to page 113

## BRANDING / AREA

Outside		
<b>1</b>	Direct print up to 4 colours	165 x 70 mm
<b>2</b>	Transfer print	208 x 100 mm
<b>3</b>	Engraving	60 x 60 mm
Inside		
<b>4</b>	Transfer print	50 x 20 mm

Cult 0911: Made in Germany productie per 01.07.2021.  
Surcharge €/pc. 0.30

# CLASSIC

Image scale 1:2



Art. 0362

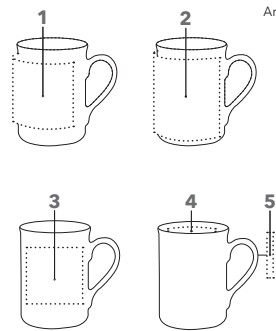

## ART. NO. 0973 / 0362

**Mug in classic design**  
high-gloss white  
**0973:** Classic, porcelain\*  
**0362:** Classic for sublimation, stoneware  
**Height:** ~ 105 mm  
**Diameter:** ~ 79 mm  
**Capacity:** ~ 0.25 l

### SERVICES

**PMS Service (Colour 4U):** see page 100  
**Packaging:** see pages 98 - 99

## INDUSTRIAL PRICES (€/PC.)

RSP in euro, per piece, VAT not included.

0973	108	250	500	1,000
<b>Plain</b>	1.80	1.75	1.66	1.61
<b>Incl. 1c Direct print, 1 position</b>	3.30	2.95	2.76	2.66
Each further print colour	1.50	1.20	1.10	1.05
<b>Incl. Engraving, 1 position</b>	4.30	3.95	3.76	3.66
<b>Incl. 1c Transfer print, 1 position</b>	3.80	3.45	3.26	3.16
Each further print colour per position	1.00	0.70	0.60	0.55
<b>0362</b>	<b>36</b>	<b>72</b>	<b>108</b>	<b>250</b>
<b>Incl. Sublimation</b>	6.00	4.90	4.30	3.95

For branding prices please refer to page 113

## BRANDING / AREA

Outside		
<b>1</b>	Direct print up to 4 colours	165 x 70 mm
	Sublimation	170 x 70 mm
<b>2</b>	Transfer print	210 x 90 mm
<b>3</b>	Engraving	60 x 60 mm
Inside		
<b>4</b>	Transfer print	50 x 20 mm
Handle		
<b>5</b>	Transfer print	50 x 5 mm

Classic 0973: Will be made in Germany from July 1, 2021.  
Surcharge: 0.30 €/pc.

# PRIME

Image scale 1:2



Transfer print



Transfer print

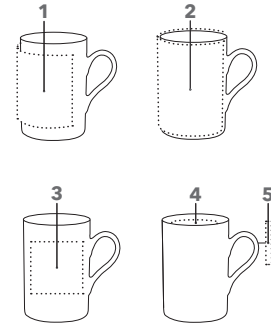

## ART. NO. 0341

**Slim porcelain mug**  
in classic shape, high-gloss white  
**Height:** ~ 106 mm  
**Diameter:** ~ 74 mm  
**Capacity:** ~ 0.25 l

### SERVICES

**PMS Service (Colour 4U):** see page 100  
**Packaging:** see pages 98 - 99

## INDUSTRIAL PRICES (€/PC.)

RSP in euro, per piece, VAT not included.

0341	108	250	500	1,000
<b>Plain</b>	1.80	1.75	1.66	1.61
<b>Incl. 1c Direct print, 1 position</b>	3.30	2.95	2.76	2.66
Each further print colour	1.50	1.20	1.10	1.05
<b>Incl. Engraving, 1 position</b>	4.30	3.95	3.76	3.66
<b>Incl. 1c Transfer print, 1 position</b>	3.80	3.45	3.26	3.16
Each further print colour per position	1.00	0.70	0.60	0.55

For branding prices please refer to page 113

## BRANDING / AREA

<b>Outside</b>	<b>1</b> Direct print up to 4 colours	145 x 70 mm
	<b>2</b> Transfer print	226 x 100 mm
	<b>3</b> Engraving	60 x 60 mm
<b>Inside</b>	<b>4</b> Transfer print	50 x 20 mm
<b>Handle</b>	<b>5</b> Transfer print	50 x 5 mm

Prime 0341: Will be made in Germany from July 1, 2021.  
Surcharge: 0.30 €/pc.

# PRIME COLOUR

Image scale 1:2



Direct print

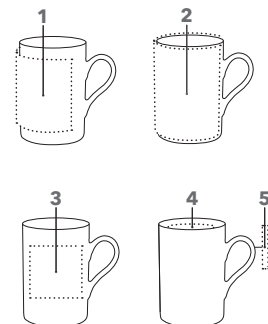

## ART. NO. 0351

**Slim stoneware mug**  
in classic shape, high-gloss coloured  
**Height:** ~ 106 mm  
**Diameter:** ~ 74 mm  
**Capacity:** ~ 0.25 l

### SERVICES

**Packaging:** see pages 98 - 99

## INDUSTRIAL PRICES (€/PC.)

RSP in euro, per piece, VAT not included.

0351	108	250	500	1,000
<b>Plain</b>	2.60	2.55	2.46	2.31
<b>Incl. 1c Direct print, 1 position</b>	4.10	3.75	3.56	3.36
Each further print colour	1.50	1.20	1.10	1.05
<b>Incl. Engraving, 1 position</b>	5.10	4.75	4.56	4.36
<b>Incl. 1c Transfer print, 1 position</b>	4.60	4.25	4.06	3.86
Each further print colour per position	1.00	0.70	0.60	0.55

For branding prices please refer to page 113

Prime 0351: Will be made in Germany from July 1, 2021.  
Surcharge: 0.30 €/pc.

## BRANDING / AREA

<b>Outside</b>	<b>1</b> Direct print up to 3 colours	145 x 70 mm
	<b>2</b> Transfer print	226 x 100 mm
	<b>3</b> Laser engraving	12 cm <sup>2</sup> (60 x 20 mm or 40 x 30 mm)
<b>Inside</b>	<b>4</b> Transfer print	50 x 20 mm
<b>Handle</b>	<b>5</b> Transfer print	50 x 5 mm

# FANCY ESPRESSO SET + ESPRESSO DUO

Image scale 1:2

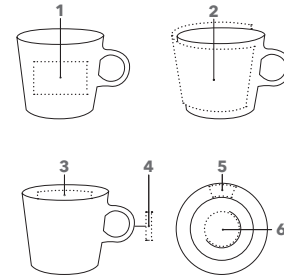

## ART. NO. 0964 / 0984

### Espresso Set 0964

Porcelain espresso cup and saucer, glossy white

### Espresso Duo 0984

2 porcelain espresso cups and saucers, glossy white, in gift box

Height: ~ 57 mm

Diameter: ~ 67 mm

Capacity: ~ 0.09 l

Diameter saucer: ~ 120 mm

## INDUSTRIAL PRICES (€/PC.)

RSP in euro, per piece, VAT not included.

0964	108	250	500	1,000
Plain	3.60	3.50	3.30	3.21
Incl. Engraving, 1 position	6.10	5.70	5.40	5.26
Incl. 1c Transfer print, 1 position	5.60	5.20	4.90	4.76
Each further print colour per position	1.00	0.70	0.60	0.55
0984	72	108	250	500
Plain	7.79	7.69	7.46	7.03
Incl. Engraving, 1 position	13.79	12.69	11.86	11.23
Incl. 1c Transfer print, 1 position	12.79	11.69	10.86	10.23

For branding prices please refer to page 113

## BRANDING / AREA

Outside	1 Engraving	40 x 15 mm
	2 Transfer print	170 x 55 mm
Inside	3 Transfer print	40 x 5 mm
Handle	4 Transfer print	30 x 3 mm
Saucer	5 Transfer print	50 x 15 mm
	6 Transfer print	Ø 45 mm

# FANCY CAFÉ + CAFÉ SET

Image scale 1:2

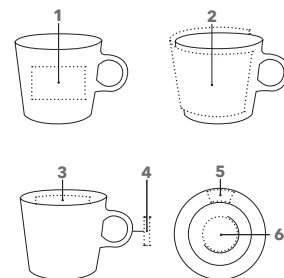

## ART. NO. 0965 / 0965-T

### Small porcelain cup with saucer 0965

in classic design, high-gloss white, suitable for coffee pod machines

### Small porcelain cup 0965-T

in classic design, high-gloss white, suitable for coffee pod machines

Height: ~ 70 mm

Diameter: ~ 83 mm

Capacity: ~ 0.2 l

Diameter saucer: ~ 144 mm

## INDUSTRIAL PRICES (€/PC.)

RSP in euro, per piece, VAT not included.

0965	108	250	500	1,000
Plain	4.01	3.90	3.69	3.58
Incl. Engraving, 1 position	6.51	6.10	5.79	5.63
Incl. 1c Transfer print, 1 position	6.01	5.60	5.29	5.13
Each further print colour per position	1.00	0.70	0.60	0.55
0965-T	108	250	500	1,000
Plain	2.20	2.14	2.02	1.96
Incl. Engraving, 1 position	4.70	4.34	4.12	4.01
Incl. 1c Transfer print, 1 position	4.20	3.84	3.62	3.51
Each further print colour per position	1.00	0.70	0.60	0.55

For branding prices please refer to page 113

## BRANDING / AREA

Outside	1 Engraving	40 x 30 mm
	2 Transfer print	195 x 60 mm
Inside	3 Transfer print	50 x 20 mm
Handle	4 Transfer print	30 x 5 mm
Saucer	5 Transfer print	40 x 20 mm
	6 Transfer print	Ø 55 mm

# FANCY PLATES

Image scale 1:4



## ART. NO. 0966 / 0993 / 0994

### Plate 0966

Porcelain, glossy white

### Dinner plate 0993

Porcelain, glossy white

### Soup plate 0994

Porcelain, glossy white

Plate Ø: ~ 213 mm

Dinner plate Ø: ~ 263 mm

Soup plate Ø: ~ 225 mm

## INDUSTRIAL PRICES (€/PC.)

RSP in euro, per piece, VAT not included.

0966	108	250	500	1,000
Plain	2.91	2.83	2.67	2.60
Incl. 1c Transfer print, 1 position	4.91	4.53	4.27	4.15
0993	108	250	500	1,000
Plain	3.31	3.22	3.04	2.96
Incl. 1c Transfer print, 1 position	5.31	4.92	4.64	4.51
0994	108	250	500	1,000
Plain	3.24	3.15	2.98	2.90
Incl. 1c Transfer print, 1 position	5.24	4.85	4.58	4.45
Each further print colour per position	1.00	0.70	0.60	0.55

## BRANDING / AREA

0966	1	Transfer print	40 x 20 mm
	2	Transfer print	Ø 100 mm
0993	1	Transfer print	100 x 20 mm
	2	Transfer print	Ø 100 mm
0994	1	Transfer print	80 x 20 mm
	2	Transfer print	Ø 100 mm

# FANCY BOWL



## ART. NO. 0920

Porcelain bowl  
glossy white

Height: ~ 76 mm

Diameter: ~ 141 mm

Capacity: ~ 0.65 l

## INDUSTRIAL PRICES (€/PC.)

RSP in euro, per piece, VAT not included.

0920	108	250	500	1,000
Plain	3.31	3.22	3.04	2.96
Incl. 1c Transfer print, 1 position	5.31	4.92	4.64	4.51
Each further print colour per position	1.00	0.70	0.60	0.55

## BRANDING / AREA

Outside	1	Transfer print	210 x 30 mm
	2	Transfer print	420 x 30 mm
Inside	3	Transfer print	50 x 30 mm

For branding prices please refer to page 113

# FANCY START - UP BOX

Image scale 1:3

Transfer print \_\_\_\_\_



## INDUSTRIAL PRICES (€/PC.)

RSP in euro, per piece, VAT not included.

0951	1	3	5	10
<b>Plain</b>	215.00	204.00	194.00	184.00
<b>Incl. 1c Transfer print Start-Up Box</b> on designated print area	400.00	352.00	319.80	302.40
<b>Incl. 2c Transfer print Start-Up Box</b> on designated print area	511.00	426.00	371.60	346.80
<b>Incl. 3c Transfer print Start-Up</b> on designated print area	622.00	500.00	423.40	391.20
<b>Incl. 4c Transfer print Start-Up Box</b> on designated print area	733.00	574.00	475.20	435.60
<b>Incl. 5c Transfer print Start-Up Box</b> on designated print area	844.00	648.00	527.00	480.00
<b>Incl. 6c Transfer print Start-Up Box 6</b> on designated print area	955.00	722.00	578.80	524.40

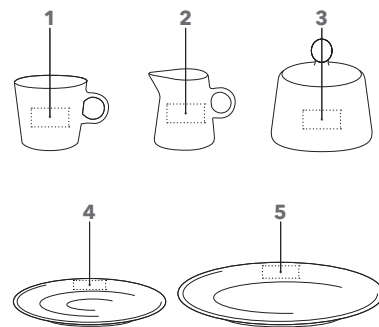

## ART. NO. 0951

### Porcelain set

74 pieces, white  
suitable for coffee pod machines:

24 cups and saucers,  
24 plates,  
1 milk jug,  
1 sugar bowl

**Height cup:** ~ 70 mm  
**Diameter cup:** ~ 83 mm  
**Capacity cup:** ~ 0.2 l  
**Diameter saucer:** ~ 144 mm  
**Diameter plate:** ~ 210 mm  
**Height milk jug:** ~ 78 mm  
**Height sugar bowl:** ~ 58 mm  
(with lid ~ 90 mm)

## BRANDING / AREA

<b>Cup</b>	1	Transfer print	40 x 20 mm
<b>Milk jug</b>	2	Transfer print	40 x 20 mm
<b>Sugar bowl</b>	3	Transfer print	40 x 20 mm
<b>Saucer</b>	4	Transfer print	40 x 20 mm
<b>Plate</b>	5	Transfer print	40 x 20 mm

# MAXIM ESPRESSO SET + ESPRESSO DUO

Image scale 1:2

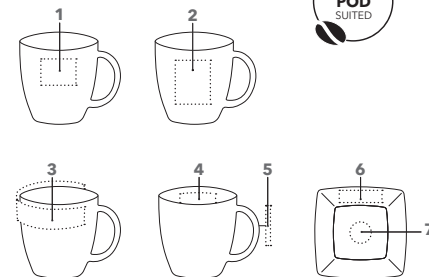

INTRODUCTION

PLASTIC PENS

METAL PENS

## ART. NO. 0977 / 0987

**Porcelain set**  
74 pieces, white  
suitable for coffee pod machines:

24 cups and saucers,  
24 plates,  
1 milk jug,  
1 sugar bowl

**Height:** ~ 55 mm  
**Diameter:** ~ 60 mm  
**Capacity:** ~ 0.08 l  
**Diameter saucer:** ~ 116 mm

## INDUSTRIAL PRICES (€/PC.)

RSP in euro, per piece, VAT not included.

	108	250	500	1,000
<b>0977</b>				
<b>Plain</b>	4.24	4.11	3.88	3.77
<b>Incl. Engraving, 1 position</b>	6.74	6.31	5.98	5.82
<b>Incl. 1c Transfer print, 1 position</b>	6.24	5.81	5.48	5.32
Each further print colour per position	1.00	0.70	0.60	0.55
<b>0987</b>	<b>72</b>	<b>108</b>	<b>250</b>	<b>500</b>
<b>Plain</b>	9.07	8.97	8.70	8.20
<b>Incl. Engraving, 1 position</b>	15.07	13.97	13.10	12.40
<b>Incl. 1c Transfer print, 1 position</b>	14.07	12.97	12.10	11.40
Each further print colour per position	1.50	1.00	0.70	0.60

## BRANDING / AREA

<b>Outside</b>	1 Engraving	40 x 15 mm
	2 Transfer print	30 x 40 mm
	3 Transfer print	170 x 10 mm
<b>Inside</b>	4 Transfer print	30 x 5 mm
<b>Handle</b>	5 Transfer print	30 x 3 mm
<b>Saucer</b>	6 Transfer print	55 x 15 mm
	7 Transfer print	∅ 25 mm

# MAXIM CAFÉ

Image scale 1:2

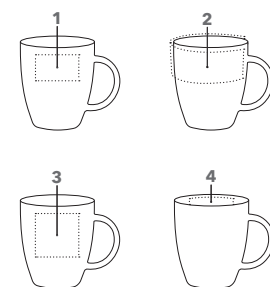

NOTEBOOKS

MUGS

## ART. NO. 0907

**Small porcelain cup**  
with unusual shape, high-gloss white,  
suitable for coffee pod machines

**Height:** ~ 82 mm  
**Diameter:** ~ 80 mm  
**Capacity:** ~ 0.2 l

## SERVICES

**PMS Service (Colour 4U):** see page 100  
**Packaging:** see pages 98 - 99

## INDUSTRIAL PRICES (€/PC.)

RSP in euro, per piece, VAT not included.

	108	250	500	1,000
<b>0907</b>				
<b>Plain</b>	2.34	2.28	2.16	2.10
<b>Incl. Engraving, 1 position</b>	4.84	4.48	4.26	4.15
<b>Incl. 1c Transfer print, 1 position</b>	4.34	3.98	3.76	3.65
Each further print colour per position	1.00	0.70	0.60	0.55

For branding prices please refer to page 113

## BRANDING / AREA

<b>Outside</b>	1 Engraving	40 x 30 mm
	2 Transfer print	215 x 20 mm
	3 Transfer print	40 x 50 mm
<b>Inside</b>	4 Transfer print	40 x 5 mm
<b>Handle</b>	5 Transfer print	50 x 5 mm

SERVICES



# MAXIM CAFÉ SET

Image scale 1:2



## ART. NO. 0937

### Porcelain set

Porcelain cup and saucer, glossy white, suitable for coffee pad machines

**Height:** ~ 82 mm

**Diameter:** ~ 80 mm

**Capacity:** ~ 0.2 l

**Diameter saucer:** ~ 148 mm

## INDUSTRIAL PRICES (€/PC.)

RSP in euro, per piece, VAT not included.

0937	108	250	500	1,000
<b>Plain</b>	4.11	4.00	3.78	3.67
<b>Incl. Engraving, 1 position</b>	6.61	6.20	5.88	5.72
<b>Incl. 1c Transfer print, 1 position</b>	6.11	5.70	5.38	5.22
Each further print colour per position	1.00	0.70	0.60	0.55

For branding prices please refer to page 113

## BRANDING / AREA

<b>Outside</b>	<b>1</b> Engraving	40 x 30 mm
	<b>2</b> Transfer print	40 x 50 mm
	<b>3</b> Transfer print	215 x 20 mm
<b>Inside</b>	<b>4</b> Transfer print	40 x 5 mm
<b>Handle</b>	<b>5</b> Transfer print	50 x 5 mm
<b>Saucer</b>	<b>6</b> Transfer print	70 x 20 mm
	<b>7</b> Transfer print	Ø 35 mm

# MAXIM PLATES

Image scale 1:2



## ART. NO. 0927 / 0997 / 0998

### Plate 0927

Porcelain, glossy white

### Dinner plate 0997

Porcelain, glossy white

### Soup plate 0998

Porcelain, glossy white

**Plate Ø:** ~ 210 mm

**Dinner plate Ø:** ~ 260 mm

**Soup plate Ø:** ~ 230 mm

## INDUSTRIAL PRICES (€/PC.)

RSP in euro, per piece, VAT not included.

0927	108	250	500	1,000
<b>Plain</b>	4.16	4.03	3.81	3.70
<b>Incl. 1c Transfer print, 1 position</b>	6.16	5.73	5.41	5.25
<b>0997</b>	<b>108</b>	<b>250</b>	<b>500</b>	<b>1,000</b>
<b>Plain</b>	4.63	4.50	4.25	4.14
<b>Incl. 1c Transfer print, 1 position</b>	6.63	6.20	5.85	5.69
<b>0998</b>	<b>108</b>	<b>250</b>	<b>500</b>	<b>1,000</b>
<b>Plain</b>	4.58	4.45	4.20	4.08
<b>Incl. 1c Transfer print, 1 position</b>	6.58	6.15	5.80	5.63
Each further print colour per position	1.00	0.70	0.60	0.55

For branding prices please refer to page 113

## BRANDING / AREA

<b>0927</b>	<b>1</b> Transfer print	70 x 25 mm
	<b>2</b> Transfer print	100 x 100 mm
<b>0997</b>	<b>1</b> Transfer print	100 x 20 mm
	<b>2</b> Transfer print	100 x 100 mm
<b>0998</b>	<b>1</b> Transfer print	80 x 20 mm
	<b>2</b> Transfer print	70 x 70 mm

For branding prices please refer to page 113

# MAXIM START-UP BOX

Image scale 1:3



## INDUSTRIAL PRICES (€/PC.)

RSP in euro, per piece, VAT not included.

0952	1	3	5	10
<b>Plain</b>	235.00	225.00	215.00	210.00
<b>Incl. 1c Transfer print Start-Up Box</b> on designated print area	420.00	373.00	340.80	328.40
<b>Incl. 2c Transfer print Start-Up Box</b> on designated print area	531.00	447.00	392.60	372.80
<b>Incl. 3c Transfer print Start-Up</b> on designated print area	642.00	521.00	444.40	417.20
<b>Incl. 4c Transfer print Start-Up Box</b> on designated print area	753.00	595.00	496.20	461.60
<b>Incl. 5c Transfer print Start-Up Box</b> on designated print area	864.00	669.00	548.00	506.00
<b>Incl. 6c Transfer print Start-Up Box 6</b> on designated print area	975.00	743.00	599.80	550.40

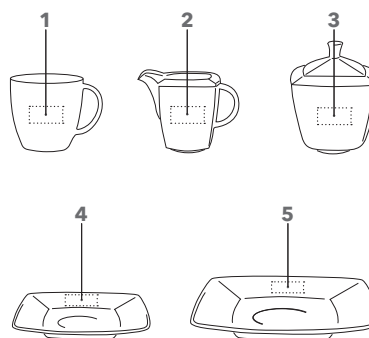

## ART. NO. 0952

### Porcelain set

74 pieces, white  
suitable for coffee pod machines:

24 cups and saucers,  
24 plates,  
1 milk jug,  
1 sugar bowl

**Height cup:** ~ 82 mm  
**Diameter cup:** ~ 80 mm  
**Capacity cup:** ~ 0.2 l  
**Diameter saucer:** ~ 150 mm  
**Diameter plate:** ~ 210 mm  
**Height milk jug:** ~ 79 mm  
**Height sugar bowl:** ~ 78 mm  
(with lid ~ 115 mm)

## BRANDING / AREA

<b>Cup</b>	1	Transfer print	40 x 20 mm
<b>Milk jug</b>	2	Transfer print	40 x 20 mm
<b>Sugar bowl</b>	3	Transfer print	40 x 20 mm
<b>Saucer</b>	4	Transfer print	40 x 20 mm
<b>Plate</b>	5	Transfer print	40 x 20 mm

INTRODUCTION

PLASTIC PENS

METAL PENS

NOTEBOOKS

MUGS

SERVICES

# PACKAGING



## ART. NO. P1A / P1A XL

**Cardboard box P1A**  
white, for 1 mug

Dimensions: 125 x 90 x 120 mm

**Cardboard box P1A XL**  
white, for 1 large mug

Dimensions: 130 x 110 x 120 mm

## ART. NO. P1B / P1B XL

**Cardboard box P1B**  
white, for 1 mug

Dimensions: 115 x 93 x 120 mm

**Cardboard box P1B XL**  
white, for 1 large mug

Dimensions: 115 x 115 x 125 mm

### INDUSTRIAL PRICES (€/PC.)

	Empty box	Price box including filling in (per mug)
<b>P1A</b> Single box, standard	0.39	0.49
<b>P1A XL</b> XL single box, standard	0.59	0.69

### INDUSTRIAL PRICES (€/PC.)

	Empty box	Price box including filling in (per mug)
<b>P1B</b> Single box, standard	0.39	0.49
<b>P1B XL</b> XL single box, standard	0.59	0.69



## ART. NO. P2 / P2 XL

**Cardboard box P2**  
white, for 2 mugs

Dimensions: 220 x 90 x 120 mm

**Cardboard box P2 XL**  
white, for 2 big mugs

Dimensions: 225 x 115 x 115 mm

## ART. NO. P4

**Cardboard box P4**  
white, for 4 mugs

Dimensions: 220 x 120 x 220 mm

### INDUSTRIAL PRICES (€/PC.)

	Empty box	Price box including filling in (per mug)
<b>P2</b> Box of 2	0.79	0.49
<b>P2 XL</b> XL Box of 2	0.89	0.54

### INDUSTRIAL PRICES (€/PC.)

	Empty box	Price box including filling in (per mug)
<b>P4</b> Box of 4	0.99	0.35

# PACKAGING



## ART. NO. P6

**Cardboard box P6 white, for 6 mugs**  
Dimensions: 215 x 120 x 325 mm

## ART. NO. P36

**Cardboard box brown, for 36 mugs**  
Dimensions: 540 x 360 x 390 mm

### INDUSTRIAL PRICES (€/PC.)

		Empty box	Price box including filling in (per mug)
<b>P6</b>	Box of 6	0.99	0.27

### INDUSTRIAL PRICES (€/PC.)

<b>P36</b>	Box of 36	Standard packaging without surcharge	
------------	-----------	--------------------------------------	--



## ESPRESSO SET / DUO SET

**White cardboard box**  
for 1 or 2 Espresso sets  
Dimensions: 132 x 110 x 132 mm

**White cardboard box**  
for 1 or 2 Café sets  
Dimensions: 172 x 172 x 155 mm

### INDUSTRIAL PRICES (€/PC.)

	Empty box	Surcharge filling-in per set
Box for 1 or 2 Café sets	1.59	1.69
Box for 1 or 2 Espresso sets	1.59	0.89

## PACKING SLIP CASE

**Slip case for all packaging**  
(except packaging P36)

Individually customisable;  
incl. 4c print,  
also available with single names  
Sizes and print areas on request

Slip case for To Go and Outdoor product packaging including 4c print,  
also available with single names

Price on request

# SENATOR WORLD OF COLOURS

## STOCK COLOURS

With senator® your corporate colour is in safe hands. The colours available for senator® ball pens offer a broad choice of surfaces and models. This gives more flexibility when selecting the best promotional ball pen to perfectly fulfil your needs.

### 10 BASIC COLOURS

Our basic models offer a combination of white with various colour accents. These basic models are available in our top 10 colours.

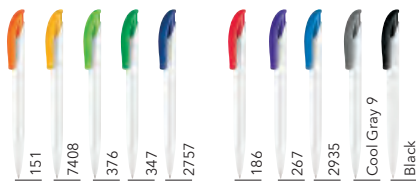

### 15 STANDARD COLOURS

In order to ensure you have the biggest possible choice and comparison, most of our plastic ball pens are available in our 15 standard colours per surface.



### LONG-TERM COLOUR GUARANTEE

We guarantee that our 15 standard colours will be available unchanged in the years ahead. You can depend on being able to make follow-up orders in the future for many years from the senator® range for your original colour tone choice.



## MIX & MATCH SERVICE

Customise our pens to fit your corporate design using the senator® Mix & Match Service. Many senator® products can be mixed in colour and surface. Contact us. We will be happy to assist you.

### COLOUR

Mix all available colours for each component of your chosen model to compliment your brand.



### MATERIAL

Choose from the available surfaces for each component and complete with an optional metal tip/clip.



### SERVICE

We will happily create a visual for your individual pen if required.



# SENATOR WORLD OF COLOURS

## PMS SERVICE MUGS

### COLOUR 4U

For those who want to use the colour of their corporate design in an even more eye-catching way, we are happy to turn our high-gloss white cups into colourful eye-catchers.

Tell us your desired colour and we will dye the exterior of your chosen mug to create the perfect eye-catcher. This service is available on all senator® white porcelain mug ranges, except for sets. We will be happy to assist you with the selection of your colour.

Our Colour 4U can achieve an incredibly broad colour range. These colours only tolerate lower burning temperatures affecting the durability. Even though these colours are suitable for use in standard dishwashers, we recommend hand washing



## PMS SERVICE PENS

You can't find your preferred colour in our catalogue products? Then check our PMS service, which will definitely offer you the right option. Simply tell us the PANTONE® number of your preferred colour and we will produce either the pen in its entirety or only specific parts with your preferred tone.

This service does require certain minimum quantities. For details, please refer to the respective product. In order to give your approval to the PMS service, we send you a sample piece produced with your preferred colour. To achieve an even higher degree of colour security (for example for the clear or frosted surfaces) we can also on request produce a pre-production sample in advance.

### INDUSTRIAL PRICES (€)

Costs for individual for individual PMS colour: 1,000.00 €

For a proof sample these costs are additional.

\*Industrial prices are to be understood as RSP in euro, ex works, VAT not included.

We can also supply our metal pens in different colours. We will be happy to advise you on colours and minimum quantities. Contact us.



Our colour references always refer to the PANTONE® Matching System, however we must point out that the product itself - because of different surfaces, lighting and materials - can differ from the colour tone printed on paper. This is why we cannot accept complaints for such deviations.

# OUR FAST DELIVERY SERVICES

## Express Service (Online Portal)

You can also simply place your orders online at any time. Including print approval. Fast and uncomplicated.

With the integrated configurator, you can create the finished print data at the same time. This saves further coordination processes and leaves you time to take care of your customers.

- We produce all articles within **5 working days**
- Plastic pens from 50 pieces
- Metal pens from 10 pieces
- Mugs from 6 pieces
- Notebooks from 10 pieces
- **Free printed samples** also available

[my.senator.com](http://my.senator.com)

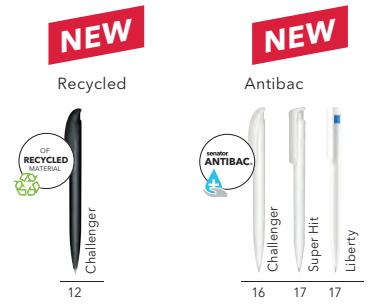

## 5,000 PENS IN 5 DAYS

You, too, can benefit from the advantages of the unique senator® "5000 in 5" services. All of your orders for volumes of up to 5,000 pieces will be produced within 5 days, including up to 5-colour printing, packaging and ready for dispatch.

- **5 days production period** from approval of the position sketch
- **up to 5,000 ball pens**
- up to 5-colour printing (1 print position)
- valid for all colours of the respective model
- blue ink
- Surcharge for this service: 0.04 €/pc.

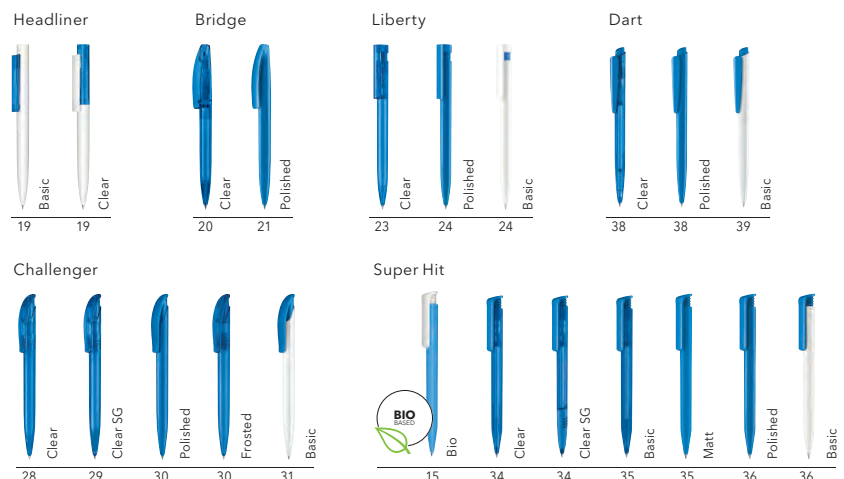

# DIGITAL SOLUTIONS

Use the senator® Challenger now with an integrated NFC tag and transmit additional digital information.

As soon as you hold an NFC-enabled smartphone to the pre-programmed NFC tag, you will see the additional information linked to the chip – individually tailored to your wishes, always up to date and alterable any time.



**NEW**

## The senator® Connected Pen Package

- We equip your Challenger with a clever NFC tag.
- When you place your order, you will receive a registration code for setting a link of your choice.
- The ball pen is thus already coded on delivery and immediately ready for use and only you can adjust the link online.
- The printed NFC scan logo informs the user of the digital function.
- You can change the link at any time via your individual login. Today, the NFC chip still refers to your homepage, for example, and tomorrow to a new promotion.

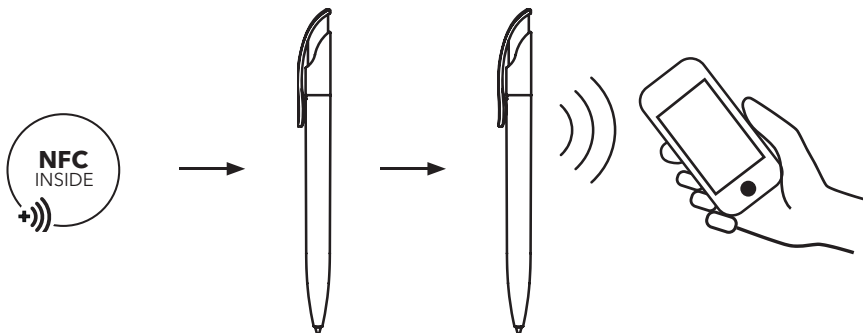

## Example applications:



### Business cards

With all important contact information including a call function



### Special Offers

With special discount code to redeem with the ball pen



### Videos

To your product and service range



### Sales documents

Price lists, catalogues, flyers always available

## INDUSTRIAL PRICES (€/PC.)

Surcharge for "Connected Pen" 0.99 €  
incl. 1c barrel print

The senator® Connected Pens are available in units of 1,000 pieces or a multiple.

The clever cloud solution allows changing content. This means that the product will always be up-to-date, even after long periods of use.



PROMOTIONAL GIFT  
AWARD 2021



# BRANDING METHODS ON PENS



## DIGITAL PRINT



### DIGITAL PRINT

Our digital print is the perfect solution to apply multicoloured prints on the clips or barrels of our ball pens. With this method we also place logos very effectively onto the cap of our Liberty models.

#### Technology:

The digital print uses the CMYK colour printing process to mix all colours from the basic four. For prints on coloured backgrounds we apply an extra layer of white underneath the print.

#### Strengths:

- Print to the edge of the clip
- Realisation of colour gradients
- Also suitable for photo-realistic themes

### DIGITAL PRINT WITH 3D EFFECT

On many white barrels of our writing instruments, large-area digital prints can be supplemented with a haptic effect. Give your brand presentation noticeably more structure and shine.

#### Technology:

The digital print uses the CMYK colour printing process to mix all colours from the basic four. An additional lacquer layer is added on top of the print for a high-gloss raised feel effect.

Minimum quantity: 1,000 pieces

#### Strengths:

- Incomparable 3D effect
- Realisation of complex colour gradients
- Reproduction of countless colours

## STANDARD PRINT



### STANDARD PRINT

Whenever it comes to branding our ball pen barrels, screen print is the branding method of our choice. For the curved clips, on the other hand, we use tampo printing. Both processes ensure optimal implementation of your brand message.

#### Technology:

Screen print is a direct print process whereby ink is pressed through a mesh onto the ball pen. Tampo print is an indirect print method whereby ink is transferred from the cliché via a silicone pad onto the surface to be printed.

#### Strengths:

- Particularly sharp-edged prints
- Accurate full colour prints possible
- Multicolour prints possible

### STANDARD PRINT WITH 3D EFFECT

The large 360° print area of our ball pen pens can be transformed into a tactile 3D surface with an additional gloss effect using an additional layer of lacquer.

#### Technology:

The lacquer layer substitutes one colour of the Barrel Print 360° and can be combined with prints of up to 4 colours. Minimum quantity: 1,000 pcs.

#### Strengths:

- Raised 3D surface
- Accentuation of selected elements
- Accurate full colour prints possible

## STANDARD PRINT ON METAL



## LASER ENGRAVING



### STANDARD PRINT ON METAL

The surfaces of our metal pens are refined by varnishes, lacquers or other surface coatings. In order to achieve a good bonding of the ink and wear resistance on these surfaces we use our special Metal print method.

#### Technology:

For the printing of our metal pens, the inks used are additionally hardened to achieve long-lasting adhesion and thus advertising duration.

#### Strengths:

- Great on varnished surfaces
- Brilliant colours
- Accurate full colour prints possible

### LASER ENGRAVING

A very elegant branding method on metal surfaces. Logos or messages are very accurately and permanently worked into the metal surface.

#### Technology:

For our laser engraving we use a high precision computer-controlled laser which engraves the surface of our writing instruments and thus expose the metal layer underneath.

#### Strengths:

- A high-class and modest result
- Extremely durable
- Suitable for individual names

# REFILLS



## senator® magic flow

1,0 mm



1,4 mm



The refill is a decisive part of the ball pen and contributes considerably to the success of the product. Therefore, when choosing a promotional ball pen, its inner values should be a primary consideration.

A high quality refill ensures a more pleasurable writing experience and guarantees higher levels of exposure and a better economic return for brands.

The **senator® magic flow** refill is one of the best in its class:

- Continuous writing with no spots of ink
- Thanks to a high quality ball and new writing ink in premium quality, this refill offers an extremely smooth and even writing experience
- In two widths:  
1.0 mm for all who prefer a clear and fine line  
1.4 mm for all who like the lines being a bit stronger
- Indelible to ISO-12757-2 and tested under stringent quality criteria to the highest demands

## BALL PEN REFILLS



8062 senator® magic flow X20 refill (1.0 mm)

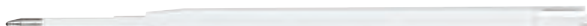

8004 senator® magic flow G2 refill (1.0 mm)



8080 senator® magic flow G2 refill (1.4 mm)



8068 senator® magic flow refill, G2

## ROLLERBALL REFILLS



1916 Safety roller plastic refill



1904 Safety roller metal refill

### BALL PEN REFILLS

Each senator® ball pen is equipped with the perfectly matching refill. We only use tested and standardised quality refills and guarantee:

- Fixed minimum filling quantities for each refill
- Indelibility to ISO-12757-2
- Compliance with customary refill systems

### INDUSTRIAL PRICES (€/PC.)

<b>8062</b>	Magic flow refill 1.0 mm, X20, blue or black	0.07
<b>8004</b>	Magic flow refill 1.0 mm, G2, blue or black	0.12
<b>8080</b>	Magic flow refill 1.4 mm, G2, blue or black	0.20
<b>8068</b>	Metal refill 1.0 mm, G2, blue or black	0.40

Change of refill and minimum quantities see page 113

### ROLLERBALL REFILLS

A characteristic of our senator® rollerball refill is the long "Cap-Off" time. A rollerball can easily be left on the table without its cap and will start writing any time

### INDUSTRIAL PRICES (€/PC.)

<b>1916</b>	Rollerball refill 0.6 mm, blue or black	0.45
<b>1904</b>	Rollerball refill metal 0.6 mm, blue or black	0.70

Change of refill and minimum quantities see page 113

# BRANDING METHODS ON NOTEBOOKS



## DIGITAL PRINT



### DIGITAL PRINT

Multicoloured printing can be realised quickly and cost-effectively with digital printing. With our notebooks, the surface can be used almost completely for printing. Only a small margin is necessary for technical reasons.

#### Technology:

The digital print uses the CMYK colour printing process to mix all colours from the basic four. For prints on coloured backgrounds we apply an extra layer of white underneath the print.

#### Strengths:

- Large print area
- Realisation of colour gradients
- Also suitable for photo-realistic themes

## EMBOSSING



### EMBOSSING

Flexible surfaces such as the outer pages of senator® paper books or our leather case can be discreetly and permanently individualized with blind embossing. This type of finishing requires no colour at all and is therefore particularly noble.

#### Technology:

The logo is permanently embossed into the material using heat and pressure with the help of a stamp.

#### Strengths:

- Understated quality
- 3D effect
- Gives company logos real impact

# BRANDING METHODS ON MUGS



## DIRECT PRINT



## TRANSFER PRINT



### DIRECT PRINT

With the Direct Print method we apply the ink directly onto the mug. This saves time and money.

Many of our mug models are suited for up to 4-colour prints, for some models this print method is restricted to 2 colours. Some print designs cannot be reproduced with the Direct Print method. We will be happy to evaluate your logo prior to printing to make sure this print method is best suited for your project.

The dimensions for the brandings stipulated in the catalogue are valid for most of the logos. Restrictions may occur depending on the logo.

#### Strengths:

- Short delivery times
- Cost-effective branding method
- Strong with line prints

### TRANSFER PRINT

Transfer Print is a branding method by which we first print the design on a label to be applied onto the mug in a second step. During the firing process the colour combines with the mug surface, the label dissolves up to a small edge around the print design.

#### Strengths:

- Endless variety
- Strong with half-tone prints
- Nearly perfect with colour gradients

## SUBLIMATION



### SUBLIMATION

The sublimation process uses pressure and heat to transfer the graphic onto a specially coated mug.

We offer this impressive branding method for a total of 9 different mug designs and King Can.

#### Strengths:

- High colour variety and brilliance
- Photo realistic prints possible
- Already available for small quantities from 36 pieces

## ENGRAVING

## COLOUR 4U



### ENGRAVING

A computer-controlled laser engraves a logo or imprint into the item ensuring absolute definition and longlasting branding.

For coloured cups, large engravings can be impressively highlighted by means of sandblasting.

#### Strengths:

- Striking tactile results
- Understated quality
- Precise reproduction of logos and lettering

### COLOUR 4U

Name your requested colour and we dye the outside of your mug to your requirements. This is possible for all white porcelain and stoneware mugs in our senator® range except for our tableware sets.

#### Strengths:

- Supremely customisable
- Colour matching on request
- Striking in combination with engraving

# PACKING UNITS

## PENS

MP = mechanical pencil, FP = fountain pen, BP = ball pen, RB = rollerball

Description	Art. No.	Catalogue page	PU	Weight PU gross	Dimensions of carton in cm	Description	Art. No.	Catalogue page	VE	Weight PU gross	Dimensions of carton in cm
Arctic	<b>3390</b>	47	250	9.7	58 x 32 x 18	Hatrix Clear SG MC	<b>2419</b>	42	500	6	38 x 30 x 18
Arvent	<b>3360</b>	48	250	7.8	58 x 32 x 18	Hatrix Polished Basic SG	<b>3200</b>	43	500	6.2	38 x 30 x 18
Arvent Soft Touch	<b>3365</b>	48	250	7.8	32.5x22.5x31.5	Hatrix Polished Basic SG MC	<b>3201</b>	43	500	6.7	38 x 30 x 18
Attract Soft Touch	<b>3325</b>	49	250	8.7	58 x 32 x 18	Headliner Clear Basic	<b>3281</b>	19	500	5.5	38 x 30 x 23
Attract Stylus	<b>3330</b>	49	250	8.7	58 x 32 x 18	Headliner Polished Basic	<b>3280</b>	19	500	5.5	38 x 30 x 23
Big Pen Mix & Match	<b>2774</b>	40		on request		Headliner Soft Touch	<b>3285</b>	18	500	5.5	38 x 30 x 23
Big Pen Polished Basic	<b>2994</b>	39	500	6.2	38 x 30 x 18	Image Black Line FP	<b>0104</b>	61	250	10	61 x 18 x 24
Bridge Clear	<b>3251</b>	20	500	5.4	38 x 30 x 23	Image Black Line BP	<b>2636</b>	60	250	11	61 x 18 x 24
Bridge Clear MT	<b>3253</b>	20	500	7	38 x 30 x 23	Image Black Line RB	<b>1119</b>	60	250	11	61 x 18 x 24
Bridge Mix & Match	<b>3256</b>	22		on request		Image Black Line Set, BP + FP	<b>6151</b>	62	15	3.6	37 x 30 x 16
Bridge Polished	<b>3250</b>	21	500	5.4	38 x 30 x 23	Image Black Line Set, BP + FP	<b>6205</b>	62	15	7.6	37 x 30 x 16
Bridge Polished MT	<b>3252</b>	21	500	7	38 x 30 x 23	Image Black Line Set, BP + RB	<b>6179</b>	62	15	3.6	37 x 30 x 16
Bridge Soft Touch	<b>3257</b>	22	500	5.4	38 x 30 x 23	Image Black Line Set, BP + RB	<b>6206</b>	62	50	7.6	37 x 30 x 16
Carbon Black	<b>3350</b>	66	250	11	61 x 18 x 24	Image Chrome BP	<b>2158</b>	64	250	10	61 x 18 x 24
Carbon Line FP	<b>0076</b>	67	250	10	61 x 18 x 24	Image Chrome RB	<b>1036</b>	64	250	11	61 x 18 x 24
Carbon Line BP	<b>2159</b>	66	250	11	61 x 18 x 24	Image Chrome Set, BP + RB	<b>6089</b>	64	15	3.6	37 x 30 x 16
Carbon Line RB	<b>1037</b>	67	250	11	61 x 18 x 24	Image Chrome Set, BP + RB	<b>6238</b>	64	50	7.6	37 x 30 x 16
Carbon Line Set, BP + FP	<b>6239</b>	66/67	20	5.8	37 x 30 x 16	Image White Line BP	<b>2786</b>	63	250	10	61 x 18 x 24
Carbon Line Set, BP + RB	<b>6240</b>	66/67	20	5.9	37 x 30 x 16	Image White Line RB	<b>1146</b>	63	250	10	61 x 18 x 24
Challenger Clear	<b>2192</b>	28	500	5.3	38 x 30 x 18	Image White Line Set, BP + RB	<b>6267</b>	63	50	7.6	38 x 30 x 18
Challenger Clear MT	<b>2925</b>	29	500	7	38 x 30 x 18	Liberty Bio	<b>3310</b>	13	1,000	9.4	38 x 30 x 23
Challenger Clear SG	<b>2597</b>	29	500	5.8	38 x 30 x 18	Liberty Clear	<b>2983</b>	23	1,000	9.4	38 x 30 x 23
Challenger Frosted	<b>2418</b>	30	500	5.3	38 x 30 x 18	Liberty Clip 4U	<b>3220</b>	27		on request	
Challenger Matt Recycled	<b>3402</b>	12	500	5.24	38 x 30 x 18	Liberty Clip 4U Soft Touch	<b>3221</b>	27		on request	
Challenger Matt Recycled Mix & Match	<b>3403</b>	12	500	5.24	38 x 30 x 18	Liberty Mix & Match	<b>2918</b>	26		on request	
Challenger Mix & Match	<b>2927</b>	33		on request		Liberty Mix & Match (Soft Touch)	<b>2829</b>	26		on request	
Challenger Polished	<b>2416</b>	30	500	5.3	38 x 30 x 18	Liberty Polished	<b>2915</b>	24	1,000	9.4	38 x 30 x 23
Challenger Polished Antibac	<b>3401</b>	16	500	5.2	38 x 30 x 18	Liberty Polished Basic	<b>2993</b>	24	1,000	9.4	38 x 30 x 23
Challenger Polished Basic	<b>2957</b>	31	500	5.3	38 x 30 x 18	Liberty Polished Basic Antibac	<b>3407</b>	17	1,000	9.4	38 x 30 x 23
Challenger Polished Basic SG	<b>2958</b>	32	500	5.7	38 x 30 x 18	Liberty Soft Touch	<b>2015</b>	25	1,000	9.4	38 x 30 x 23
Challenger Polished MT	<b>2926</b>	32	500	7	38 x 30 x 18	Liberty Soft Touch MC	<b>2942</b>	26	1,000	10.6	38 x 30 x 18
Challenger Soft Touch	<b>2737</b>	33	500	5.8	38 x 30 x 18	Nature Plus Matt	<b>2796</b>	15	500	6.7	38 x 30 x 18
Dart Clear	<b>2602</b>	38	1,000	7.3	38 x 30 x 18	Nautic Black	<b>3340</b>	58	250	9	61 x 18 x 24
Dart Polished	<b>2600</b>	38	1,000	7.3	38 x 30 x 18	Nautic BP	<b>2215</b>	59	250	9	61 x 18 x 24
Dart Polished Basic	<b>2959</b>	39	1,000	7.3	38 x 30 x 18	Nautic RB	<b>1092</b>	59	250	10	61 x 18 x 24
Delgado Classic BP	<b>2240</b>	54	250	5.5	51 x 17 x 18	Nautic Set Touch Pad Pen + RB	<b>6297</b>	59	75	8.1	62 x 17 x 22
Delgado Classic RB	<b>1030</b>	54	250	5.4	51 x 17 x 18	Nautic Touch Pad Pen	<b>2754</b>	58	250	9	61 x 18 x 24
Delgado Classic Set, BP + RB	<b>6101</b>	54	50	6.2	37 x 30 x 16	New Spring Clear MC	<b>2410</b>	44	500	6.6	38 x 30 x 18
Delgado Classic Steel BP	<b>2239</b>	55	250	5.5	51 x 17 x 18	New Spring Polished MC	<b>2310</b>	44	500	6.5	38 x 30 x 18
Delgado Classic Steel RB	<b>1029</b>	55	250	5.4	51 x 17 x 18	Phenix	<b>3380</b>	46	250	11.2	58 x 32 x 18
Delgado Classic Steel Set, BP+RB	<b>6100</b>	55	50	6.2	37 x 30 x 16	Point Metal	<b>2866</b>	41	1,000	13.7	38 x 30 x 18
Delgado Metallic BP	<b>2241</b>	56	250	5.5	51 x 17 x 18	Point Polished	<b>3217</b>	41	1,000	8.3	38 x 30 x 18
Delgado Metallic RB	<b>1031</b>	56	250	5.4	51 x 17 x 18	Polar BP	<b>3260</b>	50	100	4.8	38 x 30 x 23
Delgado Metallic Set, BP + RB	<b>6102</b>	56	50	6.2	37 x 30 x 16	Polar MKix & Match	<b>3261</b>	51	100	4.8	38 x 30 x 23
Delgado Steel BP	<b>2242</b>	57	250	5.5	51 x 17 x 18	Signer Liner BP	<b>2709</b>	65	50	1.2	25 x 17 x 15
Delgado Steel RB	<b>1039</b>	57	250	5.4	51 x 17 x 18	Skeye Bio Matt	<b>3290</b>	14	500	7.2	38 x 30 x 23
Delgado Steel Set, BP + RB	<b>6114</b>	57	50	6.2	37 x 30 x 16	Soft Spring Polished	<b>2067</b>	45	500	6	38 x 30 x 18
Duo Pen Polished	<b>2122</b>	45	1,000	8.5	32 x 49 x 18	Star Tec Alu MP	<b>3111</b>	53	250	6	40 x 18 x 19
Evovx Polished Recycled BP	<b>3273</b>	10	500	6.67	38 x 30 x 18	Star Tec Alu BP	<b>2511</b>	53	250	6	40 x 18 x 19
Galant	<b>3370</b>	51	250	7	59 x 17 x 24	Star Tec Alu Set, BP + MP	<b>6342</b>	53	50	6.1	37 x 30 x 16
Hatrix Clear SG	<b>2339</b>	42	500	6.2	38 x 30 x 18	Star Tec Steel MP	<b>3004</b>	52	250	6.3	40 x 18 x 19
						Star Tec Steel BP	<b>2040</b>	52	250	6.3	40 x 18 x 19

# PACKING UNITS

## PENS

Description	Art. No.	Catalogue page	PU	Weight PU gross	Dimensions of carton in cm
Star Tec Steel Set, BP + MP	<b>6341</b>	52	50	6.1	37 x 30 x 16
Super Hit Bio Matt	<b>3300</b>	15	1,000	9	38 x 30 x 23
Super Hit Clear	<b>2756</b>	34	1,000	7.8	38 x 30 x 23
Super Hit Clear SG	<b>2234</b>	34	1,000	8.6	38 x 30 x 23
Super Hit Frosted	<b>2244</b>	35	1,000	7.8	38 x 30 x 23
Super Hit Matt	<b>2904</b>	35	1,000	7.8	38 x 30 x 23
Super Hit Mix & Match	<b>2773</b>	37		on request	
Super Hit Polished	<b>2883</b>	36	1,000	7.7	38 x 30 x 23
Super Hit Polished Basic	<b>2955</b>	36	1,000	7.8	38 x 30 x 23
Super Hit Polished Basic Antibac	<b>3306</b>	17	1,000	7.7	38 x 30 x 23
Super Hit Polished Basic SG	<b>2956</b>	37	1,000	8.6	38 x 30 x 23
Tizio FP	<b>0240</b>	67	250	10	61 x 18 x 24
Tizio BP	<b>2400</b>	68	250	11	61 x 18 x 24
Tizio RB	<b>1240</b>	69	250	11	61 x 18 x 24
Tizio Set, BP + FP	<b>6252</b>	69	20	6	37 x 30 x 16
Tizio Set, BP + RB	<b>6253</b>	69	20	6	37 x 30 x 16
Trento Matt Recycled	<b>3305</b>	11	1,000	9	38 x 30 x 23

## CASES

ET 150	<b>ET150</b>	72	320	11	32 x 42 x 33
ET 154	<b>ET154</b>	73	200	11	31 x 35 x 32
ET 156	<b>ET156</b>	72	80	8	38 x 33 x 35
ET 157	<b>ET157</b>	71	1,320	9	52 x 25 x 22
ET 160	<b>ET160</b>	72	60	13.5	44 x 43 x 34
ET 169	<b>ET169</b>	73	250	7	42 x 42 x 19
ET 171	<b>ET171</b>	73	180	9.5	50 x 35 x 29
ET 190	<b>ET190</b>	71	250	12.95	58 x 38 x 33

## NOTEBOOKS

Notebook Structure	<b>NB01</b>	74	25	9.9	38 x 30 x 23
Notebook Structure Magnet	<b>NB02</b>	74	25	9.9	38 x 30 x 23
Notebook Soft	<b>NB03</b>	75	25	8.3	38 x 30 x 18
Holder Soft	<b>NB04</b>	75		on request	
Notebook Paper	<b>NB05</b>	76	25	4.5	38 x 30 x 23
Notebook Paper, small	<b>NB06</b>	76	20	2.4	32 x 24 x 17

## MUGS

Description	Art. No.	Catalogue page	PU	Weight PU gross	Dimensions of carton in cm
Amity	<b>0321</b>	84	36	10.8	54 x 39 x 36
Appeal	<b>0928</b>	87	36	14.8	54 x 39 x 36
Charisma	<b>0915</b>	87	36	10.4	54 x 39 x 36
Classic	<b>0973</b>	90	36	11.6	54 x 39 x 36
Cosmos	<b>0926</b>	86	36	13.9	54 x 39 x 36
Cult	<b>0911</b>	90	36	11.3	54 x 39 x 36
Elegant	<b>0381</b>	81	36	11.8	40 x 28 x 34
Elite	<b>0912</b>	83	36	10.3	54 x 39 x 36
Elite Inside	<b>0353</b>	82	36	11.7	37 x 26 x 33
Elite Matt	<b>0343</b>	83	36	11.5	37 x 27 x 34
Fancy Café	<b>0965T</b>	92	12	1.8	90 x 18 x 16
Fancy Café Set	<b>0965</b>	92	12	7	30 x 18 x 15
Fancy Plate	<b>0966</b>	93	12	4.2	23 x 23 x 13
Fancy Espresso Duo	<b>0984</b>	92	20	9.5	46 x 37x 28
Fancy Espresso Set	<b>0964</b>	92	12	2.6	26 x 14 x 20
Fancy Bowl	<b>0920</b>	93	36	17.2	54 x 39 x 36
Fancy Dinner plate	<b>0993</b>	93	12	10.5	27 x 26 x 13
Fancy Start-Up Box	<b>0951</b>	94	1	18.5	46 x 41 x 37
Fancy Soup plate	<b>0994</b>	93	12	5	23 x 23 x 16
King Can	<b>0755</b>	78	36	9.3	32 x 24 x 50.5
King Can Mini	<b>0785</b>	79	36	6.4	32 x 24 x 43
Maxi Mug	<b>0344</b>	88	36	11.5	54 x 39 x 36
Maxim	<b>0914</b>	85	36	10.5	54 x 39 x 36
Maxim Café	<b>0907</b>	95	36	7.8	39 x 27 x 31
Maxim Café Set	<b>0937</b>	96	108	16	45 x 34 x 44
Maxim Plate	<b>0927</b>	96	12	6.1	23 x 22 x 15
Maxim Espresso Duo	<b>0987</b>	95	20	9.5	46 x 37x 28
Maxim Espresso Set	<b>0977</b>	95	12	2.6	34 x 26 x 75
Maxim Dinner plate	<b>0997</b>	96	12	10.5	27 x 27 x 16
Maxim Start-Up Box	<b>0952</b>	97	1	24.5	45 x 44 x 41
Maxim Soup plate	<b>0998</b>	96	12	7.7	24 x 25 x 16
Outdoor	<b>0373</b>	80	36	6.3	32 x 32x 36.5
Pics Classic	<b>0362</b>	90	36	12.5	54 x 39 x 36
Pics Cosmos	<b>0356</b>	86	36	14.1	54 x 39 x 36
Pics Elite	<b>0354</b>	83	36	11.6	54 x 39 x 36
Pics Elite Inside	<b>0355</b>	82	36	11.5	54 x 39 x 36
Pics King Can	<b>0765</b>	78	36	9.6	32 x 24 x 50.5
Pics Mini	<b>0371</b>	89	36	8	35.5 x 25.5 x 24.5
Pics One	<b>0323</b>	88	36	13	54 x 39 x 36
Pics Outdoor	<b>0372</b>	80	36	6.3	32 x 32x 36.5
Pics Solid	<b>0358</b>	86	36	14	54 x 39 x 36
Pics Two	<b>0324</b>	89	36	13.6	54 x 39 x 36
Prime	<b>0341</b>	91	36	11.9	54 x 39 x 36
Prime Colour	<b>0351</b>	91	36	12.1	35 x 26 x 36
Trophy	<b>0750</b>	79	36	8.3	53 x 27 x 39

This information applies to unprinted goods and may vary for printed goods.



# ARTWORK

## GENERAL INFORMATION

Please send us your artwork in the below mention file types or send text in on of our standard typefaces.

Please also provide a print sample or proof if possible.

Please send logos and text as vectorised files or as TIF-files with 1200 dpi, in case of photos we require a resolution of 600 dpi.

Vectorised logos can be scaled without any loss in quality and are to be preferred against pixel files.

Below mentioned minimum font sizes and minimum line widths are guidelines only. Depending on the motive, branding method or product surface smaller letters and finer lines might be possible or larger letters or bigger lines might be necessary.

### Proof samples

To make sure you get the best possible result we recommend the production of a sample for approval. (For production reasons slight colour deviations between a print on paper and a print on other materials are unavoidable).

### File formats

Adobe Photoshop CC 2020  
Adobe Illustrator CC 2020  
Adobe Indesign CC 2020  
Corel Draw X8  
(Please convert all texts into curves)

## PENS

### Print colours

With the available colour shade mixing range, all Pantone C and HBP K shades can be mixed. Slight colour shade deviations between paper flags and print are unavoidable on white underground. Major colour shade deviations on an underground of a different colour shade or on a dark-shaded underground must be tolerated.

### Digital print

All colours are mixed in CMYK, so it is not possible to print real PMS colours. In nearly every case the colours will be close to. Very large, uni coloured surfaces cannot be realised. Minimum size: 8 pt, minimum line width: 0.15 mm

### Laser engraving

Minimum line width: 0.15 mm, Minimum front size: 6 pt

### Personalisation (list of names)

Many of our products can be customised with the personal name. Please send us the names in an excel file.

### Raster

Screen print: Raster of 40, colour intensity 15 - 85%.  
360° barrel print: Raster of 48, colour intensity 15 - 85%

### Standard Typefaces

Arial, AvantGarde, Courier, Futura, Present, Serifa, Helvetica, Times New Roman, Univers each regular, bold, italic, bold italic, BrushScript, English script type each italic and bold italic. Other typefaces possible (only PC), please send font as True Type-face (\*.ttf).  
Other or similar typefaces on request.

## MUGS

### Direct Print

On white mugs

Without trapping in the design:

Minimum size 10 pt, minimum line width 0.2 mm, no raster

With trapping in the design:

Minimum size 10 pt, minimum line width 0.5 mm, no raster

On coloured mugs a white layer will always have to be layed underneath:

Minimum size 24 pt, minimum line width 0.8 mm, no raster

### Transfer print on stainless steel and coloured mugs

Minimum size 12 pt, minimum line width 0.35 mm, printable colour intensity 15 - 85 %.

### Laser engraving on stainless steel

Minimum size 8 pt, minimum line width 0.2 mm.

### Laser engraving on coloured mugs

Minimum size 12 pt, minimum line width 0.4 mm

### Personalisation (list of names)

A great variety of our mugs can be customised with the personal name. Please send us the names in an excel file. Please note that this very special way of customisation is always possible when the name stands for itself and is not part of the remaining design.

### Sandblasting

Minimum size 24 pt, minimum line width 1 mm, no raster

### Sublimation

Minimum size: positive 8 pt, negative 10 pt  
Minimum line width: positive 0.2 mm, negative 0.3 mm, no raster

### Transfer print

Minimum size 8 pt, minimum line width 0.2 mm, printable colour intensity 15 - 85 %

# BRANDING PRICES (INCLUDING PRE-CHARGES)

## PENS + NOTEBOOKS

### Standard print (per print position and colour)

	10	25	50	100	250	500	1,000	2,500	5,000
€/pc.	5,10	2,10	1,10	0,60	0,30	0,20	0,15	0,12	0,11

### Digital print (per position)

	250	500	1,000	2,500	5,000
€/pc.	0.45	0.35	0.30	0.27	0.26

### Digital print on notebooks

	25	50	100	250
1/3 area €/pc.	3.60	2.80	2.40	2.16
2/3 area €/pc.	5.60	4.80	4.40	4.16
3/3 area €/pc.	7.60	6.80	6.40	6.16

### Laser engraving (per position)

	10	25	50	100	250	500	1,000
€/pc.	5.50	2.50	1.50	1.00	0.70	0.60	0.55

### Embossing

	10	25	50	100	250	500	1,000
€/pc.	16.20	7.20	4.20	2.70	1.80	1.50	1.35

Minimum quantities depend on the model.

## MUGS

### Direct print (per print position and colour)

	72	108	250	500	1,000
€/pc.	2.00	1.50	1.20	1.10	1.05

### Transfer print (jper print position)

	72	108	250	500	1,000
1st colour €/pc.	2.50	2.00	1.70	1.60	1.55
each further colour €/pc.	1.50	1.00	0.70	0.60	0.55

### Engraving (per print position)

	72	108	250	500	1,000
€/pc.	3.00	2.50	2.20	2.10	2.05

### Sublimation

	36	72	108	250	500	1,000
€/pc.	4.00	3.00	2.50	2.20	2.10	2.05

### Colour 4U

	108	250	500	1,000
€/pc.	2.50	2.20	2.10	2.05

# ADDITIONAL SURCHARGES

## DELIVERIES

### Labelling

Labelling of single pens, gift boxes, polybags (10, 20, 25, 50, 100er) and outer carton. Per label: 0.15 €

### Delivery quantity:

As stated in our general business terms, we reserve the right to over or under delivery. For delivery by exact number, we charge: 2% surcharge on product and branding

### Minimum order surcharge

The minimum quantities are defined by the lowest quantity scale and packing unit per model and colour. For orders below the minimum quantity (but at least half the quantity) we charge 50.00 €

### Return of neutral goods

Return of unprinted goods in original packaging is possible within 4 weeks after dispatch and after consultation with us. We charge a handling fee per position of: 50.00 €

### Shipping to distributor plan

Handling fee per additional shipping address, packing included (plus shipping costs): 8.00 €

Change of ball pen or rollerball refill per piece: 0.15 €  
 Minimum quantity for plastic pens: 1,000 pcs.  
 Minimum quantity for metal pens: 100 pcs.  
 For our models Super-Hit, Dart, Liberty (except for version with metallised tip), Point Metal, Star Tec and Delgado a change of refill is not possible! The surcharge is to be understood plus price for the refill.

## PRODUCTION

### Proof sample

Proof sample per colour & position (plus product price): 40.00 €

### Print

To achieve a better printing result it is sometimes recommended to print a white layer underneath the print or to apply the print twice. In these cases printing charges are invoiced once more.

### PMS Service

Almost all of our models are available in individual colours according to PMS on request. The minimum quantities are for plastics models 20,000 pieces, mugs 1,000 pieces. For a proof sample these costs are additional. 1,000.00 €

## PACKAGING

### Plastic pens

Printed pens are packed in polybag of 100 pcs. Exception: Super-Hit and Dart are bulk packed in carton. Different packaging (e. g. 10, 25, 50 or 100 pcs. in poly bag) or in box of 50 ball pens per 100 pieces: 1.10 €

Single packaging in poly bag. per 100 pieces: 10.00 €

### Metal pens

are packed in a plastic tray of 10. Exception: Polar in a cardboard tray of 10 Single packaging in polybag, 10.00 €

Valid from April, 1, 2021

With this price list all previous prices and conditions lose their validity. All prices are industrial prices and are to be understood as recommended selling price in euro per piece, ex works, excluding VAT. Whilst our catalogues are prepared with utmost care SENATOR GmbH cannot guarantee the completeness and accuracy of the information provided.

Our general terms apply. You will find these at [www.senator.com](http://www.senator.com)



## SENATOR® RECYCLED PENS

### OUR GREEN SUPER HEROES.

If sustainability is just as important to you as good design, then the three senator® Recycled Pens are the models of your choice: made from recycled material and produced in Germany with CO<sub>2</sub>-neutral green electricity.

#### The new senator® recycled pens

We use a >95% recycled ABS ReCompound. This means reusing industrial production scraps and waste, returns and everyday products.

The three new senator® models made from post-industrial recycled material show that good design does not have to be sacrificed in the process.

#### EVOXX Unmistakable appearance

- Striking look
- With practical grip indents

#### TRENTO Clever recycling power

- Straight shape
- Economical use of materials

#### CHALLENGER Longstanding popular design

- Bestselling design
- Also configurable in Mix & Match

